

PELLET STOVE

## DANIA Air Tight Plus DANIA Air Tight C Plus



The original language of this manual is Italian

EDILKAMIN S.p.A., with registered offices in Via  
Vincenzo Monti 47 - 20123 Milan - tax code and VAT  
number 00192220192

Declares, under its sole responsibility, that:

The pellet stove mentioned below is conforming with  
EU Regulation 305/2011 and harmonised EU standard  
EN 14785:2006

PELLET STOVE, tradename EDILKAMIN, models  
DANIA AIR TIGHT C  
DANIA AIR TIGHT

SERIAL NUMBER: Nameplate reference

Performance declaration:

DANIA AIR TIGHT C/ DANIA AIR TIGHT (DoP - EK n° 193)

Nameplate reference

And also declares that:

the wood pellet stove satisfies the requirements of the  
following European directives:

2014/35/EC - Low Voltage Directive

2014/30/EC - Electromagnetic Compatibility Directive

Dear Sir/Madam

We thank you for and congratulate you on choosing our product. Before using it, we ask you to read this manual carefully, in order for you to be able to make the most of all its functions in total safety.

This manual is an integral part of the product. We ask you to keep it for the entire lifetime of the product. If you lose it, you can request a copy from your dealer or download it from [www.edilkamin.com](http://www.edilkamin.com).

### Readers of this manual

This manual is addressed to:

- those who will use the product at home ("USER");
- the technician who will install the product ("INSTALLER")

The target person of each page is indicated in a band at the bottom of the page (USER or INSTALLER).

After unpacking the product, check the condition and completeness of the contents.

In the event of error, immediately contact the retailer where the purchase was made, providing them with a copy of the warranty booklet and the sales receipt.

The appliance must be installed and operated in compliance with local and national law and European regulations. For the installation, and for anything not specifically indicated in the manual, observe local regulations.

The diagrams provided in this manual are for illustration purposes only: they do not always strictly refer to your specific model, and are not binding in any way.

Identification of the product and warranty.

The product is uniquely identified by a number, the "counterfoil", which is indicated on the warranty certificate.

Please keep:

- the warranty certificate accompanying the product
- the purchase receipt given to you by the retailer
- the declaration of conformity given to you by the installer.

The warranty conditions are given in the warranty certificate accompanying the product.

### MEANING OF SYMBOLS

In some parts of the manual the following symbols are used:



#### ATTENTION:

carefully read and understand the message in question, since failure to follow the instructions in it could cause serious damage to the product and put the safety of those using it at risk.



#### INFORMATION:

failure to comply with these requirements will compromise product use.



#### OPERATING SEQUENCE:

follow the instructions for the operations described.

- The appliance is not designed for use by people, including children, with limited physical, sensory and mental capacities.
- The appliance is not intended to be used for cooking.
- The appliance is designed to burn UNI EN ISO 17225-2 category A1 wood pellets, in the amounts and manner described in this manual.
- The appliance is designed for use indoors, in normal conditions of ambient humidity.
- Keep the product in a dry place out of the weather.
- For the legal and company warranties, refer to the warranty certificate inside the product: neither Edilkamin nor the reseller are liable for damage resulting from incorrect installation or maintenance.

Safety risks may be caused by:

- installation in unsuitable conditions. In particular, conditions of fire hazard. **DO NOT INSTALL THE PRODUCT IN AREAS SUBJECT TO THE RISK OF FIRE.**
- contact with fire and hot parts (e.g. glass panel and pipes). **DO NOT TOUCH THE STOVE'S HOT PARTS**; always wear the gloves when working with the stove, even if switched off, when it is still hot. Failure do so can result in burns.
- contact with live electrical equipment (internal). **DO NOT ACCESS THE INTERNAL ELECTRICAL EQUIPMENT WHILE THE APPLIANCE IS POWERED ON.** Electrocutation hazard.
- use of improper ignition aids (e.g. alcohol). **DO NOT IGNITE OR BOOST THE FLAME WITH FLUID SPRAYS OR A FLAME TORCH.**
- use of fuel other than wood pellets. **DO NOT BURN WASTE MATTER, PLASTIC OR OTHER MATERIALS THAN WOOD PELLETS IN THE HEARTH.** The product may be soiled, the flue may catch fire, and environmental damage may ensue.
- cleaning the hearth when hot. **DO NOT CLEAN THE HEARTH WITH A VACUUM CLEANER WHILE IT IS HOT.** Risk of damage to the cleaner and smoke in the room.
- cleaning the fumes duct with cleaning products. **DO NOT CLEAN THE PRODUCT WITH FLAMMABLE PRODUCTS.** Risk of fire and blowback.
- cleaning the hot glass pane with unsuitable cleaning products. **DO NOT CLEAN THE GLASS WHILE IT IS HOT WITH WATER OR ANY OTHER PRODUCT THAN THE RECOMMENDED GLASS CLEANING PRODUCTS.** Risk of cracking and irreparable damage to the glass.
- storing flammable materials within the safety clearance indicated in this manual. **DO NOT PLACE LAUNDRY ON THE PRODUCT. DO NOT PLACE DRYING RACKS WITHIN THE SAFETY CLEARANCE.** Keep flammable fluids away from the product. Fire hazard.
- blocking the aeration vents and air intakes in the room. **DO NOT BLOCK THE AERATION VENTS OR FLUE.** Risk of smoke returning into the room with consequent damage and injury.
- use of the product as a support or ladder. **DO NOT CLIMB ONTO THE PRODUCT OR USE IT AS A SUPPORT.** Risk of damage and injury.
- use of the stove with the hearth open. **DO NOT USE THE PRODUCT WITH ITS DOOR OPEN.**
- incandescent material projected from the open door. **DO NOT** throw incandescent material outside the appliance. Fire hazard.
- use of water in case of fire. **CALL THE AUTHORITIES IF A FIRE BREAKS OUT.**

Please use all normal precautions for a household heating appliance.

Connect the product to electricity supply only after having completed its assembly and mounted the cladding. Otherwise there is a risk of having "live" electrical parts exposed.

If you have doubts, please do not take any action, but contact the retailer or the installer.

For reasons of safety, read the user instructions included in this manual.

**DIMENSIONS (cm)**

**DANIA AIR TIGHT PLUS**

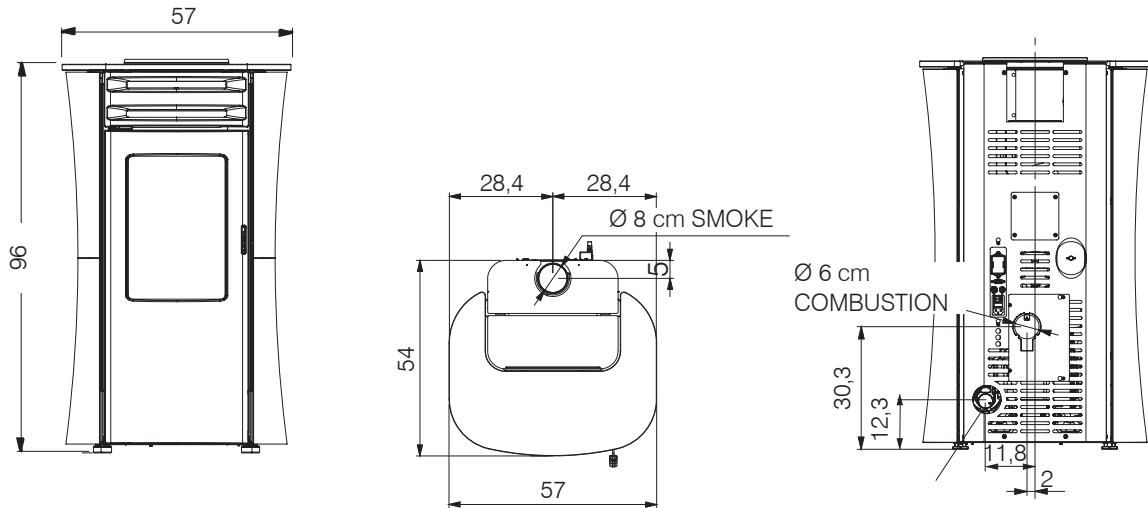

**DANIA AIR TIGHT C PLUS**

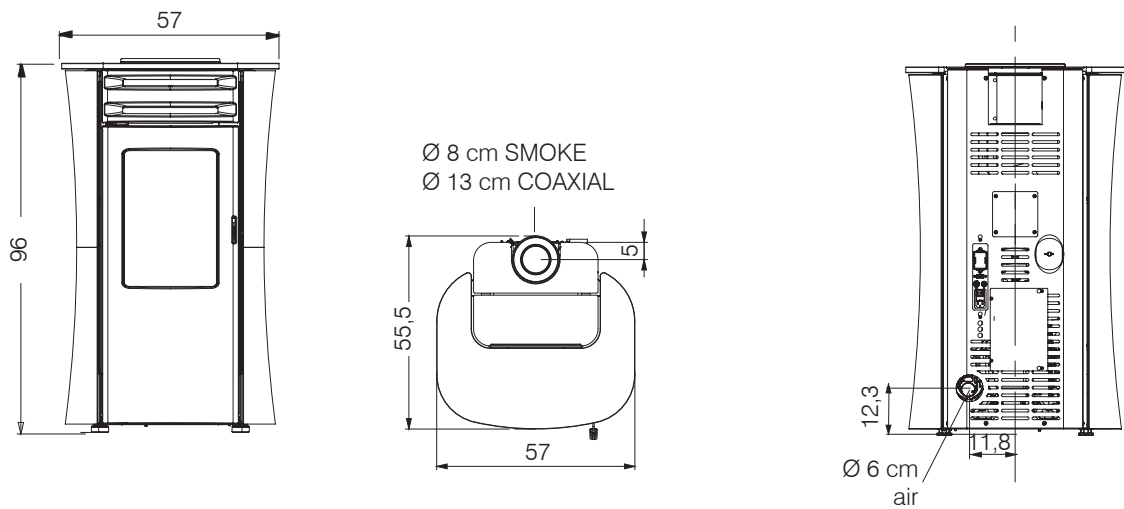

**TECHNICAL CHARACTERISTICS in accordance with EN 14785** The data shown below refers to the actual installation and use and was taken during the certification phase by a notified body under the conditions specified by the standard. **Best results are achieved with the clean glass system closed. Use the supplied gasket, by the installer.**

	<b>DANIA AIR TIGHT DANIA AIR TIGHT C PLUS</b>		
	Potenza Nominale	Potenza Ridotta	
Available power	8	2,6	kW
Yield	91,3	90,1	%
CO emissions at 13% O <sub>2</sub>	0,003	0,021	%
Fumes temperature	166	106	°C
Fuel consumption *	1,8	0,6	kg/h
Tank capacity	18		kg
Draw	11		Pa
Autonomy	10	30	ore
Heatable volume **	210		m <sup>3</sup>
Fume duct diameter	80/130		mm
Weight including packaging	137		kg
Energy efficiency class according to UE 2015-1186 regulation (Class A+ +/G)	A+		

\*A calorific value of 4.8 kW/Kg has been used to calculate consumption.

\*\* The heatable volume is calculated based on the assumption of a heating demand of 33 Kcal/m<sup>3</sup> hour.

**TECHNICAL DATA FOR SIZING THE FLUE** which must in any case satisfy the requirements in this sheet and the installation instructions for the product.

	Nominal power	Reduced power	
Fumes temperature at smoke outlet	199	106	°C
Minimum draw	11		Pa
Fumes flow rate	5,6	2,8	g/s

**ELECTRICAL SPECIFICATIONS**

Power supply	Vac +/- 10% 50 Hz
Nominal power absorbed	180 W
Reduced power absorbed	78 W
Power absorbed in stand by	2 W
Power absorption during ignition	365 W
Remote control frequency (provided)	2,4 GHz
Protection	Fusibile 4 AT, 250 Vac 5x20

**EDILKAMIN s.p.a. reserves the right to modify the product without notification in the interests of improvement.**



Edilkamin S.p.A.  
20045 Lainate (MI), via P. Mascagni 7  
Tel. +39 02 937621  
Fax +39 02 93762 400/300  
mail@edilkamin.com  
www.edilkamin.com

Capitale € 4.100.000 int. vers.  
Sede legale:  
20154 Milano, Via P. Moscati 8  
Reg. Imp. di Milano 00192220192  
REA n° 878888  
Cod. Fiscale e Partita IVA 00192220192

TECHNICAL DOCUMENTATION FOR LOCAL SPACE HEATERS ACCORDING TO COMMISSION REGULATION (EU) 2015/1185 AND 2015/1186

Manufacturer	Edilkamin S.p.A.
Trademark	Edilkamin
Model Identifier	Dania Air Tight Plus - Dania Air Tight C Plus
Description	Mechanically space heater fired by wood pellets
Indirect heating functionality	no
Direct heat output (space heat output)	8 kW
CPR harmonised standard	EN 14785
Notified Body	Acteco srl (Via Amman 41 ,33084 Cordenons-PN-Italy) NB1880

Fuel	Preferred fuel (unique)	Space heating emissions at nominal heat output				Space heating emissions at minimum heat output			
		PM	OGC	CO	NOx	PM	OGC	CO	NOx
(*) PM = particulate matter, OGCs = organic gaseous compounds, CO = carbon monoxide, NOx = nitrogen oxides									
Compressed wood with moisture content < 12 %	yes	11	4	23	131	16	10	262	109

Observe the specific precautions for installation, assembly and maintenance indicated in the manual accompanying the product

Up to 1/1/2022	
η <sub>s</sub> [%]	84,9
EEL [%]	125
Energy Efficiency Class	A+

From 01/01/2022	
η <sub>s</sub> [%]	84,9
EEL [%]	125
Energy Efficiency Class	A+

Calculations according to the council commission regulation (EU) 2015/1186 and 2015/1185  
Characteristics when operating with the preferred fuel

$$EEI = (\eta_{s,om} \cdot BLF) - 10\% + F(2) + F(3) - F(4) - F(5)$$

BLF = 1,45       $\eta_{s,om} = \eta_{th,nom}$

$$\eta_s = \eta_{s,om} - 10\% + F(2) + F(3) - F(4) - F(5)$$

F5 not of relevance

Heat output			
Item	Symbol	Value	Unit
Nominal heat output	P <sub>nom</sub>	8	kW
Minimum heat output (indicative)	P <sub>min</sub>	2,6	kW

Useful efficiency (NCV as received)			
Item	Symbol	Value	Unit
Useful efficiency at nominal heat output	η <sub>th,nom</sub>	90,1	%
Useful efficiency at minimum heat output (indicative)	η <sub>th,min</sub>	91,3	%

Auxiliary electricity consumption			
Item	Symbol	Value	Unit
At nominal heat output	e <sub>l,max</sub>	0,180	kW
At minimum heat output	e <sub>l,min</sub>	0,078	kW
In standby mode	e <sub>l,sp</sub>	0,002	kW

Type of heat output/room temperature control (select one)	
single stage heat output, no room temperature control	NO
two or more manual stages, no room temperature control	NO
with mechanic thermostat room temperature control	NO
with electronic room temperature control	NO
with electronic room temperature control plus day timer	NO
with electronic room temperature control plus week timer	yes

$$F(4) = CC \cdot \frac{0,2 \cdot e_{l,max} + 0,8 \cdot e_{l,min} + 1,3 \cdot e_{l,sp}}{P_{nom}} \cdot 100[\%]$$

F (2)	7,0 %	up to 2022
F (2)	7,0 %	from 2022
Other control options (multiple selections possible)		
room temperature control, with presence detection		NO
room temperature control, with open window detection		NO
with distance control option		yes

F (3)	1,0 %	up to 2022
F (3)	1,0 %	from 2022

Contact details	
Name and address of the manufacturer	www.edilkamin.com
EDILKAMIN S.p.A.	mail@edilkamin.com
Via Mascagni 7	Legal Representative
20045 Lainate (MI) – ITALY	Paolo Gusella

**PREPARATION AND UNPACKING**

The packaging materials are neither toxic nor noxious and do not require special disposal.

The user is responsible for storing, disposing of and recycling them in a regulatory fashion.

In the stove you will find:

- remote control,
- warranty certificate,
- this manual,
- power cable.

The lever for opening the interior door is on the pallet.



Always move the stove vertically with suitable equipment and in compliance with safety regulations.

Do not turn the package over, and handle all parts requiring installation with care.

Package materials such as plastic and films may be dangerous for children.

Suffocation hazard.

Keep packages away from children.





DO NOT REMOVE THE PRODUCT FROM THE PALLET BEFORE LOOSENING THE SCREWS.

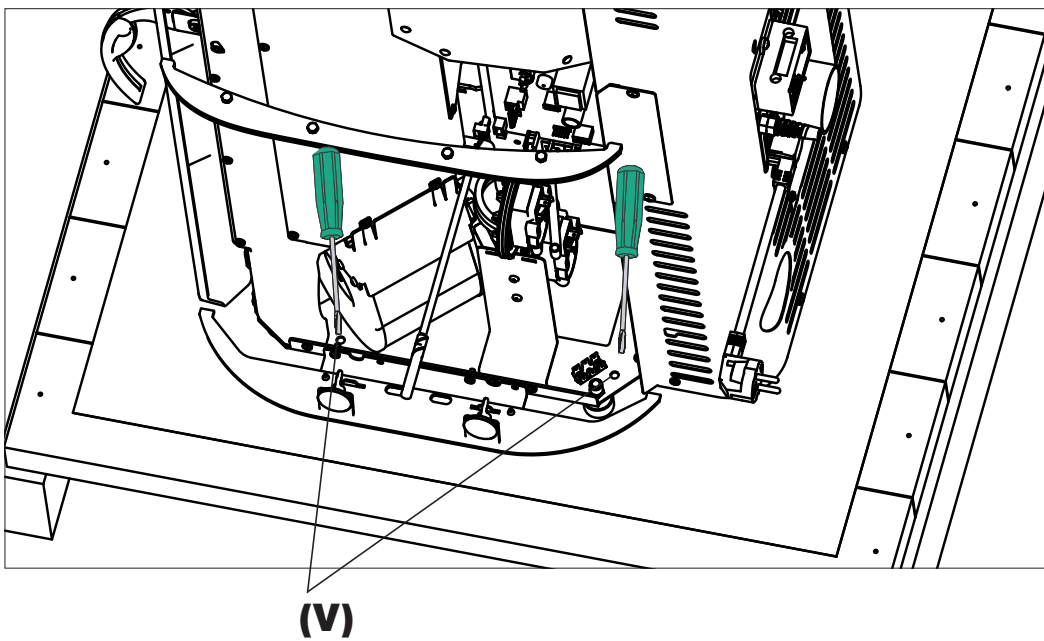
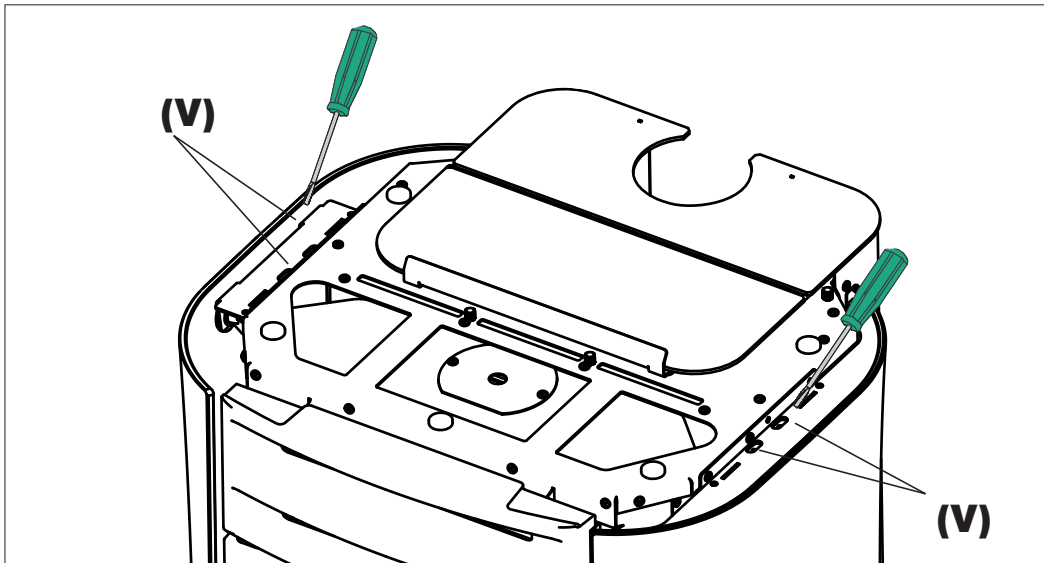

INDICATIVE DRAWINGS, NOT ALWAYS REFERRING TO THE SPECIFIC MODEL.

INSTALLER

**REMARKS ON INSTALLATION**

Note that:

- installation must be carried out by authorised technical personnel;
- the appliance must be installed and operated in compliance with local and national law and European regulations. The Italian reference standard is UNI 10683; in France one must follow the instructions in the DTA (Document Technique d'Application Référence Avis Technique), [www.cstb.fr](http://www.cstb.fr)
- if installed in a condominium, the appliance must be approved by the administrator;
- if installed in public premises, check and follow local regulations for this type of installation.

Here are a few general instructions, although these do not obviate the need to comply with local regulations and do not affect the installer's liability for the installation.

Remember that Rada Air Tight C is sealed, in other words, if it is installed correctly with the air inlet pipe connected to the outside, it takes the majority of the air from the outside. For different countries, check if there are particular installation conditions allowed for sealed stoves.

**Checking the suitability of the installation space**

- The room must have a volume of at least 30 m<sup>3</sup>
- The floor must be able to bear the weight of the product and its accessories\* (see the note in the paragraph on the heat protection)
- Level the appliance
- Pursuant to Standard 10683 rev. 2012 point 6.3, in Italy you can also install the appliance in bedrooms or in rooms which already include a product that takes air from it for combustion, provided that the air inlet is connected to the outside
- Do not install the product in spaces where there is a risk of fire or explosion
- In Italy, check the compatibility pursuant to UNI 10683 and UNI 7129 in the presence of gas fired products.

**Protection from heat and safety clearances**

The surfaces of the building adjacent to the product must be protected against overheating.

The insulation to be used will depend on the type of surface in question.

The appliance must be installed in accordance with the following safety instructions:

- minimum clearance at the sides 5 cm and back of 10 cm from flammable materials
- no flammable materials may be kept closer to the front of the appliance than 80 cm.

If connected to a wooden or otherwise flammable wall, the flue must be appropriately insulated.

If installed on a flammable or combustible floor, or which is not capable of bearing its load\*, use steel or glass plates under the stove to distribute the load. Contact the retailer for this type of optional.

**Positioning the product**

The product is designed to operate in all climate conditions. In special circumstances, such as strong wind, the safety devices may intervene to switch the appliance off.

Contact the authorised Edilkamin Technical Assistance Centre.

**INSTRUCTIONS FOR THE SMOKE DISCHARGE WITH OR WITHOUT CONCENTRIC PIPE**

**FLUE SYSTEM**

**(fumes duct, flue and chimney pot)**

This chapter has been drawn up pursuant to European regulations EN 13384, EN 1443, EN 1856 and EN 1457. The installer must observe both these and any other local regulations. This manual does not in any way substitute such regulations.

The product must be connected to a flue system which ensures that the fumes produced by combustion are expelled in complete safety.

Before positioning the appliance, the installer must check that the flue is suitable.

**FUMES DUCT, FLUE**

The fumes duct (which connects the combustion chamber smoke outlet with the flue) and the flue itself must, among other regulatory requirements:

- receive the fumes from a single product (the outlets of multiple appliances may not be conveyed into a single flue)
- be routed vertically for the most part
- have no downwards sloping sections
- preferably have a circular internal cross section, or with a ratio of the sides of less than 1.5
- terminate at roof level with a proper chimney pot: the flue may not discharge directly on the wall or into an enclosed space, even if the space in question is open to the sky
- be made of material with rated fire reaction class A1 as per UNI EN 13501 or analogous national regulations
- be certified, with a chimney plate if metal
- be of uniform cross section or vary in cross section only immediately after the outlet, not at some midpoint of its length.

**THE FUMES DUCT**

- Further to the general prescriptions for the fumes duct and flue, the fumes duct:
- may not be made of flexible metal material
- must be insulated, if routed through unheated areas or outdoors
- must not be routed through rooms where the installation of combustion heat generators is prohibited or there is risk of fire, or that cannot be inspected
- must enable the recovery of soot and be open for inspection
- must have a maximum of 3 bends with a maximum angle of 90°
- if there is a horizontal section, it can have a maximum length of no more than 3 metres, depending on the draw. Note, in any case, that long sections encourage the accumulation of dirt and are harder to keep clean.

**THE FLUE:**

Further to the general prescriptions for the smoke duct and flue, the flue:

- must only be used for discharging fumes
- must be correctly sized to satisfy the requirements for fume discharging (EN 13384-1)
- should preferably be insulated, in steel with a circular internal section. If rectangular, the corners must have a radius of not less than 20 mm, with aratio of the internal dimensions of <1.5
- must normally be at least 1.5 metres in vertical length
- must have a constant cross section
- must be waterproof and thermally insulated to ensure a good draw
- preferably provide a collection chamber for unburnt residues and condensates
- if pre-existing, must be clean, to prevent fire hazards
- in general, we recommend fitting a tube inside the existing masonry chimney if its diameter is greater than 150 mm.

**INTUBATED SYSTEM:**

Further to the general prescriptions for the fumes duct and flue, the intubated system:

- must operate in negative pressure;
- must be open to inspection;
- must observe local regulations.

**THE CHIMNEY POT** (In every country and specially in France, check on the specific waiver conditions)

- must be anti-downdraught
- must have an internal cross section equivalent to that of the flue and a fumes outlet at least double that of the interior of the flue
- for dual flues (which should be spaced at least 2 m apart) the chimney pot receiving the fumes from the solid fuel appliance or that from the higher storey, must be at least 50 cm higher than the other
- it must extend beyond the back flow zone (in Italy, refer to UNI 10683 point 6.5.8.)
- it must allow for maintenance of the chimney.

**COMBUSTION AIR INTAKE**

The inflow of necessary air for combustion, of air for glass cleaning and heating air renewal must come from the outside

**Sealed stoves can also be installed in passive houses. In this case, the air inlet must be a direct air inlet. The stove takes the air from the outside via the air inlet hole.**

**Install an air intake with an effective surface area (net of the mesh or other protective equipment) at least equal to the cross section of the air inlet hole.**

Connect the air intake to the appliance's air intake with a pipe that may also be flexible. Increase the diameter of the pipe if the pipe is not smooth or if it is necessary due to load losses: assess the load losses.

We recommend that it does not exceed 1 metre in length or include any bends.

If you are not interested in the sealing feature of the appliance, you can create an indirect air intake, even if this is not recommended

Install an air outlet at floor level with an effective surface area (net of the screen or other protections) of at least 80 cm<sup>2</sup> (diameter 10 cm).

To prevent draughts, we recommend installing the intake behind the product or behind a radiator.

Installing it in front of the appliance will create unpleasant draughts.

The air may be drawn from an adjacent room only if:

- the flow is taken from permanent, unobstructed openings communicating with the outdoors
- the air pressure in the adjacent room is never reduced to a level below outdoor pressure
- the adjacent room is not a garage, subject to fire hazard, a bathroom or a bedroom
- the adjacent room is not a shared room in the condominium

In Italy, UNI 10683 provides that ventilation is sufficient even if a pressure difference between the outdoors and indoors of no more than 4 PA is guaranteed (UNI EN 13384-1). The installer who issues the declaration of conformity is responsible for ensuring these conditions.

**USE OF CONCENTRIC PIPES**

Without prejudice to the general instructions, you can use concentric pipes (which provide for the passage of smoke inside and the passage of the combustion air into the external circular ring).

This type of installation only needs one hole in the wall, instead of having one hole for the air intake and one for the smoke discharge.

Examples of possible installations. For the smoke discharge conditions (on roof, etc.) check local regulations for sealed pellet stoves.

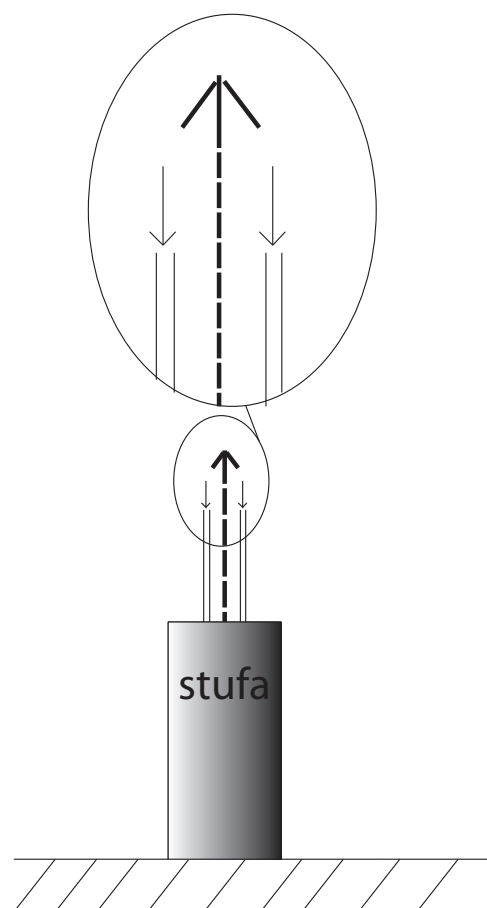

Upper coaxial fumes discharge and air intake

**CHECKING THE ELECTRICAL CONNECTIONS  
(the power socket must be located in an  
easily accessible position)**

The stove is equipped with an electrical power cord or connection to a 230V 50 Hz socket, preferably with an electromagnetic switch.

Variations in voltage of more than 10% can compromise the operation of the stove.

The electrical system must be compliant; check the operation of the earth in particular.

Edilkamin is not responsible for malfunctions resulting from an improperly earthed system.

The power line must be of adequate section for the power of the appliance.

The power cable must not come into contact with the flue or other hot parts of the stove.

Power up the stove by setting its switch from 0 to 1.

There is a 4 A fuse on the socket with switch located at the rear of the stove.

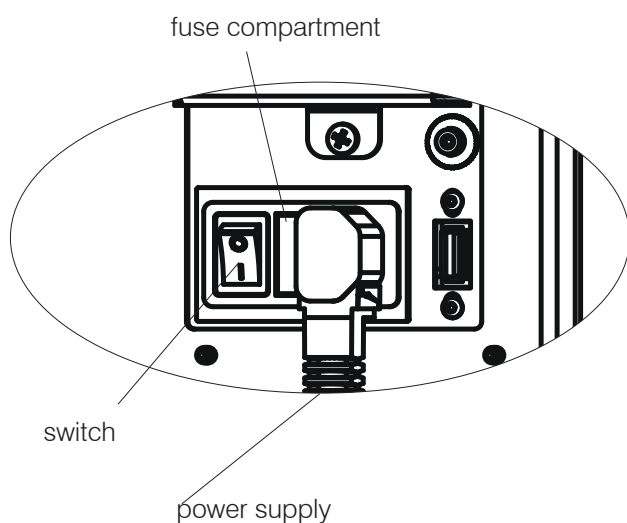

**FIRST IGNITION PROCEDURE**

- Make sure you have read and understood this manual
- Remove all flammable materials from the appliance (manuals, labels, etc). Make sure to remove the labels on the glass.



Using fuels other than those specified can damage the appliance

**LOADING THE PELLETS INTO THE PELLET TANK**



- When doing so, DO NOT rest the bag of pellets on the top grille, since the plastic bag may melt and damage the appliance's paint.
- Use the gloves when loading the stove while it is operating and hence hot to the touch.
- Take care not to touch the fume exhaust pipe when hot.

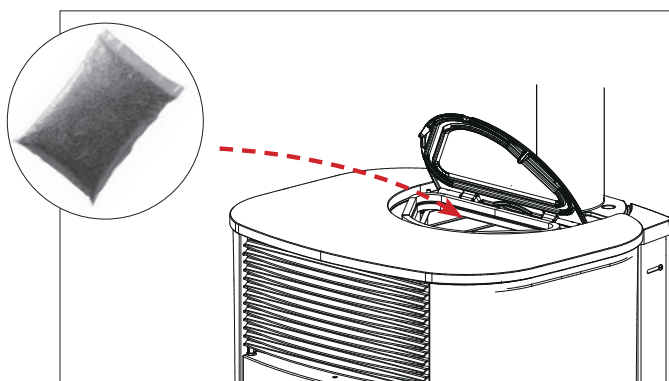
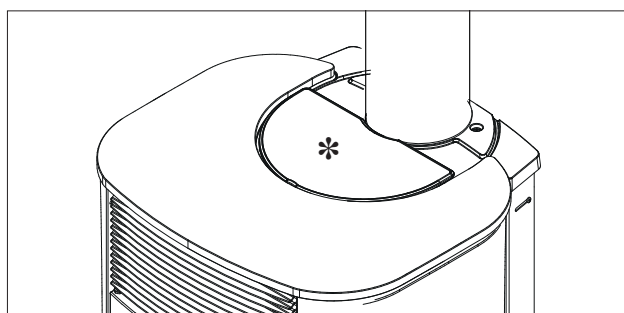

**COMBUSTIBLE**

Use BS EN ISO 17225-2 category A1 wood pellets or similar certified products with the following characteristics  
 diameter: 6 mm; maximum  
 length: 4 cm, maximum  
 moisture: 10 %,

**NOTES:**

- IN RESPECT OF THE ENVIRONMENT AND FOR SAFETY REASONS, DO NOT BURN PLASTIC MATERIALS, VARNISHED WOOD, COAL, BARK AND WOOD WASTE.
- DO NOT USE THE STOVE AS AN INCINERATOR.



Caution  
 Using fuels other than those specified can damage the appliance

**OPERATION**

Mode	Settable parameters
MANUAL	<ul style="list-style-type: none"> <li>power level</li> <li>ventilation level (the fans, if more than one, can be adjusted separately)*</li> </ul>
AUTOMATIC	<ul style="list-style-type: none"> <li>desired room temperature</li> <li>ventilation level *</li> </ul>
TIMER	<ul style="list-style-type: none"> <li>desired room temperature, selected per day of the week</li> <li>ventilation level*</li> </ul>

\* when lowering the ventilation, the product can automatically modulate its power to maintain maximum efficiency.

The product also has the following supplementary functions.

Function	Modes in which it can be activated	What it does
Stand-By	automatic timer-based	when the desired temperature is reached, the product switches off and then back on again when the temperature drops
RELAX	manual automatic timer-based	enables natural convection mode (fan off), thus reducing the power
EASY TIMER	manual automatic	is used to programme the switching off/on after a set number of hours (maximum 12 hours)

**OPTIONAL CONNECTIONS**

The technician can supply, on request:

- external thermostat;
- telephone dialler;
- probes/thermostats for managing the ducting fans (if present on the purchased model)

**INTERFACE**

Alternatively, the product can be managed, as a standard configuration, in the following ways:

- Bluetooth REMOTE CONTROL: used for all functions, near the product
- Wi-Fi APP: used for all functions even outside of home, with Internet connections

If necessary, a few functions can also be managed from a:

- SAVE PANEL: panel used for the on/off functions; power setting

By purchasing the Edilkamin optional elements included in the range:

- UMTS MODEM: used for managing a few functions, even outside of home, by means of a mobile telephone

By purchasing the non-Edilkamin optional elements:

- VOICE CONTROL SYSTEMS Alexa or Google Home



**REMOTE CONTROL**

The remote control has specific functions for three distinct figures:

- user of the product (operations not protected by password)
- installer (operations with dedicated password because any errors can jeopardise the product's operations and SECURITY)
- Edilkamin technical assistance centre (operations with dedicated password because any errors can jeopardise the product's operations and SECURITY)

**Characteristics:** Module for RF transmission and reception with 2.4 GHz frequency - Recommended power supply 3 x AA slimline 1.5 VDC batteries (with at least 1600 mAh capacity).



Risk of explosion if the batteries are replaced with other batteries of an incorrect type.

**If at the first switch-on operation** the language is not set, the adjacent language selection screen will appear. Choose the language with the +/- buttons and confirm with OK.

**REMOTE CONTROL POWER SAVING**

After 20" of non-use the backlighting decreases and after a further 10" the display switches off.

If any button is pressed with the display on, the counter resets.

If any button is pressed with the display off, the display and the backlighting will switch on and the counter will reset. This only refers to the remote control, not the product itself.

In normal use, the remote control's batteries should last a year. This duration is for illustrative purposes only. Edilkamin and the reseller will not consider claims for battery life under any circumstances.





Bluetooth communication present between the stove and the circuit board. If there is no communication, the symbol disappears.



On only if the battery is running out. The power level supplied by the batteries is near the limit for powering the remote control.



Maintenance necessary symbol. Appears after a certain number of hours of operation.



The relative function is active (Relax – airKare – EasyTimer – Crono).

**EasyTimer and Crono cannot be activated simultaneously.**



°C/F. Indicates the unit of measurement of the displayed temperature: degrees centigrade (°C) or Fahrenheit.



Reserve indicator It switches on if the function is active. The arrows switch on in sequence to signal that the tank must be filled.



Presence of flame and stove power

SWITCH-ON

POWER 1

POWER 2

POWER 3

POWER 4

POWER 5





Visualisation of the status of the fan(s).

If the activation fume temperature has not been reached, it will not display any symbol.

SPEED OFF

SPEED 1

SPEED 2

SPEED 3

SPEED 4

SPEED 5

AUTOMATIC



**STAND-BY**

The stand-by function (where present and active) has caused the product to switch off. It does NOT indicate that the function is enabled.

**AUTO MAN**

Automatic or Manual mode: the product's air power depends on the room temperature or is set by the user.

**SET**

Setting. Indicates that the remote control is in the setting mode. The settable value will appear in the bottom bar.

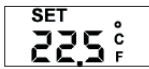

Digits for SET-POINTS. Setting of the various SET-POINTS: temperature, power, fan speed. Number of the parameter in the parameter setting section.

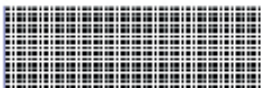

Bottom bar for weekly scheduling and messages.

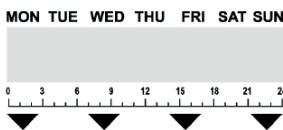

The days of the week and time bar will only appear if the timer (Crono) is activated.

**POSSIBLE STATUSES** of the product

**- OFF STATE**

The product is “deactivated” and will not produce heat due to manual switching off using the ON/OFF button on the remote control or due to an external contact (timer, telephone dialler).

From the OFF page, press the ON/OFF button for 3 seconds to access the ON page.

**- ON STATUS**

The product is “active” and can fulfil the heating requests.

**- ALARM STATUS**

In case of a stoppage due to an alarm.

**- ON STATUS Stand-by activated**

The product is momentarily off because there are no heating requests.

**POWER ON/POWER OFF**

These operations will take a few minutes, during which the flame must appear or switch off. Simply wait without taking any action.

The ON/OFF button is used to manually start the on or off phase.

**During the switch-on,**

the display will show the status (CLEANING; SWITCH-ON; etc.)

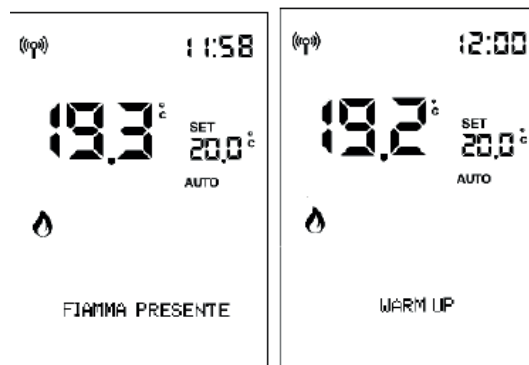
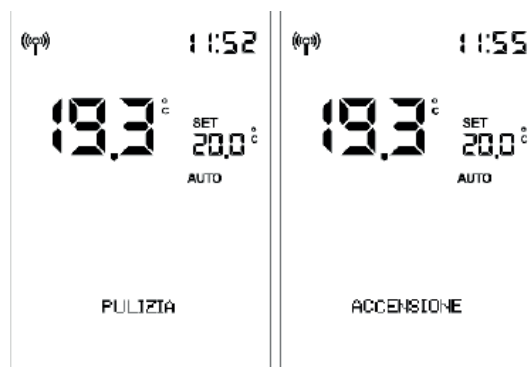

**During the switch-off,** the display will show the word "OFF".



**If time scheduling is active,** the status bar will alternately show (3 seconds) the status and the programming:

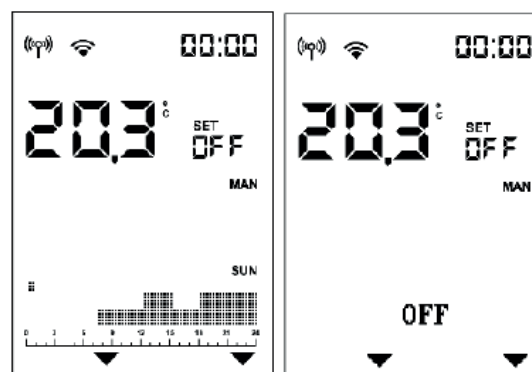

**AUTOMATIC and MANUAL setting**

Press the AUTO/MAN button for a few seconds to switch from manual to automatic mode or vice versa.

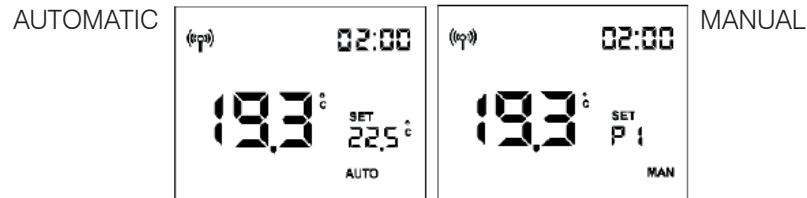

**In AUTOMATIC mode:**

**Setting of the room temperature** (read by the remote control, which should be located in the room where the product is installed). Modify the desired temperature using the “+” and “-” buttons.

For example: press any button and the display will activate, then press the button 

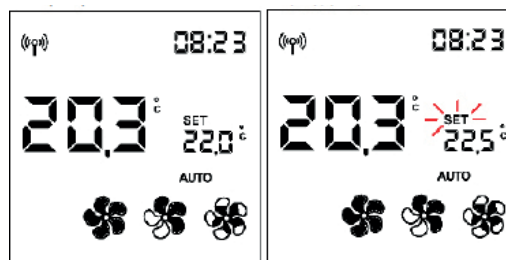

**In MANUAL mode:**

**Setting of the power**

Modify the power level (displayed by the flame symbol) using the “+” and “-” buttons.

For example: press any button and the display will activate, then press the button 

“flame”  
symbol

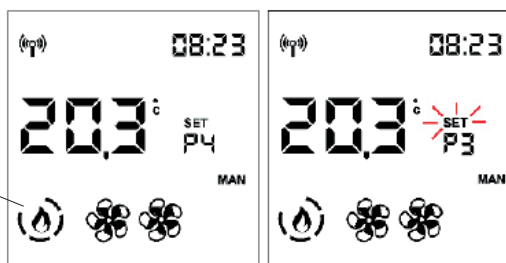

The setting can be confirmed with the  button or by waiting 5" without pressing any button. After confirming, SET will stop flashing.



NOTE

With Timer and product “off », it is not possible any regulation (power nor temperature)

**- FAN ADJUSTMENT**

The setting can be made with the stove turned OFF or ON.  
If the backlight is switched off, it can be activated by pressing any button.



Pressing the  or  button will make SET flash and, instead of the room set-point, the number of the fan being modified will appear (F1). Simultaneously, the fan speed can be increased or decreased in the following sequence:  
AUTO - 1 - 2 - 3 - 4 - 5 for the front fan (1)  
OFF - AUTO - 1 - 2 - 3 - 4 - 5 for the ducted fans (2 and 3)

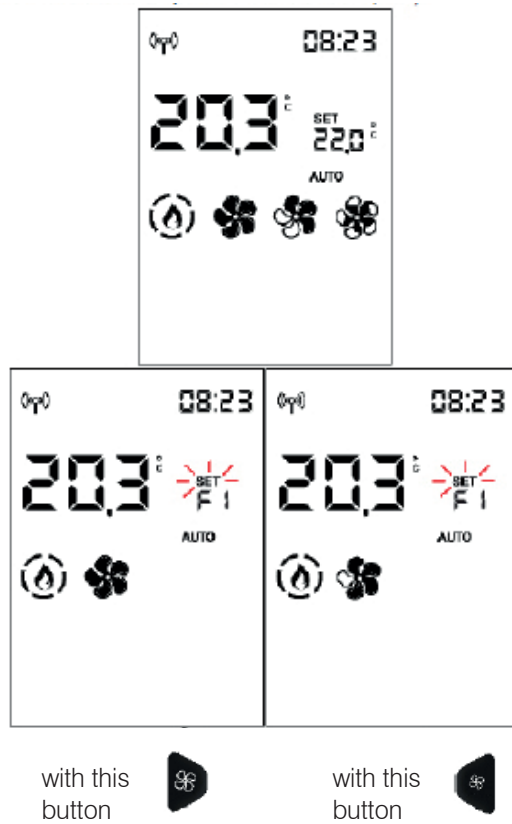

The ventilation is adjusted in sequence for the various fans (if present). If the product is not ducted, only one fan will be present (F1).  
The fan speed can be increased or decreased in the following sequence:  
AUTO – 1 – 2 – 3 – 4 – 5 for the front fan (1)  
OFF – AUTO – 1 – 2 – 3 – 4 – 5 for the ducted fans (2 and 3)





**for PLUS versions**

Pressing the  button to confirm will take you to the next fan (Fan 2), if present.

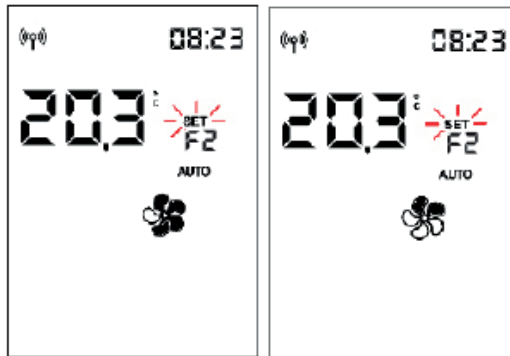

Pressing the  or  button modifies the fan speed.



You can confirm the setting with the  button and then move to the next fan, if present, otherwise you can exit the fan setting page and “SET” will stop flashing. Otherwise, wait 5" without pressing any button to exit the fan setting, and SET will stop flashing, even if there are other fans.

Pressing the  button to confirm will take you to the next fan (Fan 3), if present. Waiting 5" without pressing any button takes you back to the home page with the modified SET.



**for PLUS versions with optional room probe**

**DUCTED ZONES 2 AND 3 ROOM SET-POINT**

The setting can only be made with ducted-air stoves.

If two or more optional room probes are connected and activated, it is possible to set the relative room set-point and display the room temperature.

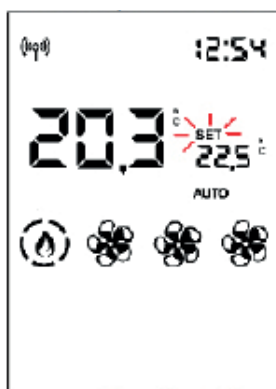

After setting the installation room temperature (or with the room power in manual mode), wait 5" without pressing any button and "SET" will flash then you will exit the settings page.

Otherwise, if you confirm with the  OK button, you can set the room set-point of zone 2 (if the probe is present and active) indicated on the bottom bar.



Press OK to move to the next zone (zone 3), if present, or exit.

**- RELAX FUNCTION**

Natural convection function (without ventilation) with automatic power limiting.

This function is available in all modes: automatic, manual and timer-based.

Press and hold the  button to activate the Relax function.

Its activation on the display will be signalled by the arrow relative to the Relax button.

Prolonged pressing of the button  will deactivate the function.

The product reduces its power output and after a few minutes switches the fan off too.



**- AIRKARE FUNCTION** airKare 

This function is available as a standard feature on certain models and as an optional feature on other models: check which model you have.

The function, if available, can be activated with the stove either on or off, in any mode (except in alarm mode).

The airKare can be activated by pressing the dedicated button



Its activation on the display will be signalled by the arrow relative to the airKare button.

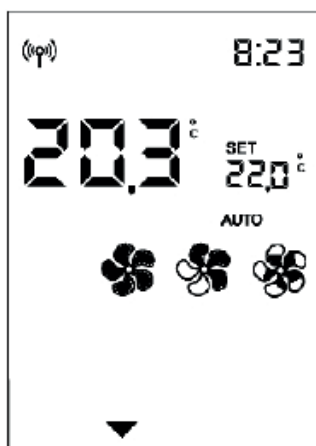

**- EASY TIMER (deferred switching on/off)**

This function switches the product on/off after a set period from activation of the function. This is convenient if you go to bed and want the product to switch on/off after a few hours (maximum 12 hours).

The Easy Timer function can be activated by pressing the dedicated button. 

By activating the Easy Timer function with the product on, the switch-off time can be set with ½ hour intervals. By activating the Easy Timer function with the product off, the user sets the switch-on time.

Pressing the OK button or after 5" without pressing any button, the countdown will start with 5-minute intervals.

Example: Switch-off in 30 minutes' time.



The bar will continue Countdown can be read until the product switches on or off.

The Easy Timer function can be deactivated by pressing the dedicated button. The display will show an arrow above the button and the countdown.

To change the timer before the switching on or off, it must be deactivated and then reset.

## **TIMER**

Timer regulation is possible by MENU

If the product is in automatic mode, the product works at room temperature otherwise it works with the power.

Pressing the  button allows for switching from Temperature Timer to Power Timer and vice versa.

Pressing the  button activates or deactivates the timer (pre-programmed from the app or remote control).

### NOTE

Timer regulation is possible by MENU. « Crono » key is only used to turn off/on Crono

**- MENU**

It can be accessed by pressing the  button and the first Menu item will appear.

The menu items can be scrolled with the  and  buttons and the item can be entered with the  button.

The menu items appear in the following order:

- 01 STAND-BY
- 02 PELLETT LOAD
- 03 CHRONO PROG. (TIMER)
- 04 T1-T2
- 05 DATE-HOUR (TIME)
- 06 C/F
- 07 LANGUAGE
- 08 DISPLAY
- 09 INFO
- 10 SOFTWARE
- 11 DATA
- 12 ALARMS
- 13 AUGER MOT. ON-OFF (SCREW FEEDER)
- 14 PLT LVL SENS (PELLET LEVEL SENSOR)
- 15 TECHNICAL MENU

The set-point digits contain the progressive number of the menu item, while the status bar includes the description of the menu item in large letters.

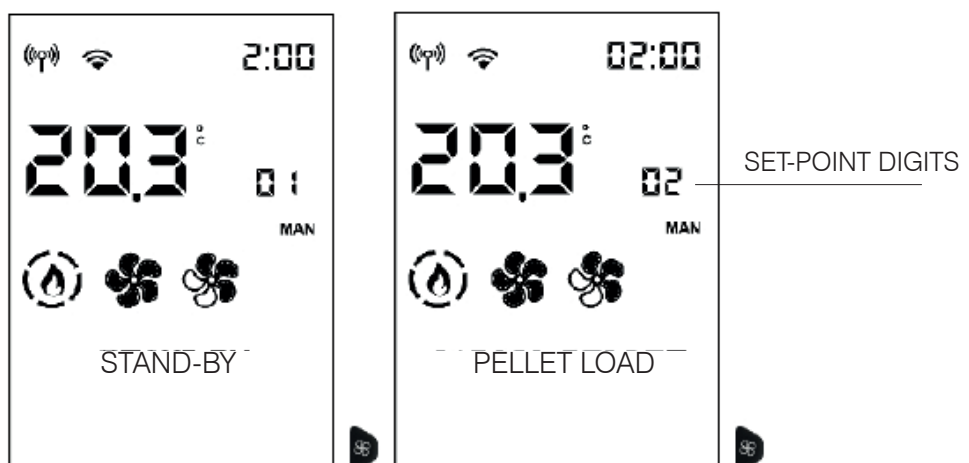

To exit the menu, press .

**- STAND-BY**

When the Stand-by function is active, in the automatic and timer modes, the product switches off once the temperature set-point is reached and turns on again when the room temperature drops below the chosen value.



When the Stand-by function is not active, the product sets itself to minimum power when the temperature set-point is reached.

To access the function from the main menu (as indicated in the Menu section above), press the MENU button.

The menu items can be scrolled with the  and  buttons and the item can be entered with the  button.

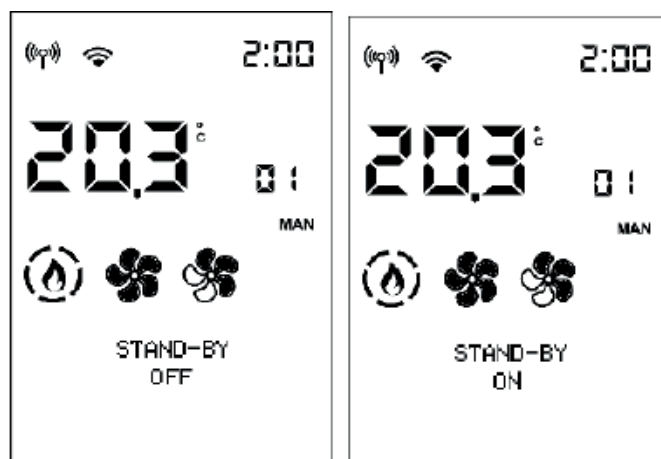
After entering the Stand-by function, the display will show the name of the function on the first line of the status bar and the current value on the second line (OFF if deactivated, ON if active).



The  and  buttons can be used to modify the value from Off (function deactivated) to On (activated) and the  button can be used to confirm.



Pressing the  button with the value ON activates the function and the display will propose to choose how many minutes must pass before the devices switches off in stand-by mode.  
(es: 5 minutes)

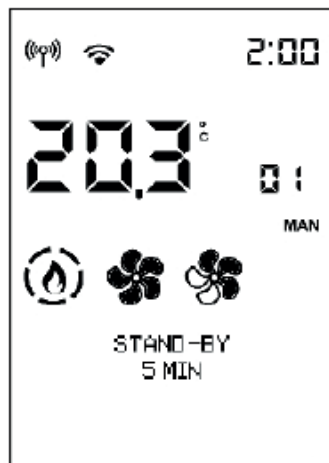

The  and  buttons can be used to modify the time and the  button to confirm.

Pressing the  button automatically takes you to the first level.



**- PELLET LOAD**

Allows you to load pellets after the screw feeder has emptied.

Useful for the technician during the initial start-up.

Available only in the OFF status. Any attempt to activate the function in other statuses will not be allowed.



To access the function from the main menu (as indicated in the Menu paragraph above), press the M button. Scroll using the +/- buttons and select the function by pressing OK.

To access the function from the main menu (as indicated in the Menu paragraph above), press the MENU button.

The menu items can be scrolled with the  and  buttons and the item can be entered with the  button.

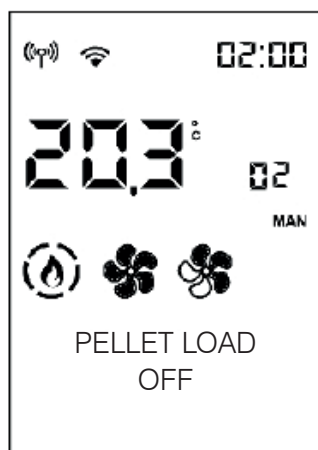
After entering the Screw Feeder Manual Loading function, the display will show the name of the function on the first line of the status bar and the current value on the second line (OFF if deactivated, ON if active).





The  and  buttons can be used to modify the value from Off (deactivated) to On (activated) and vice versa, while the “+” and “-” buttons can be used to adjust the value.

Pressing the  button automatically takes you to the first level.

**- CHRONO PROG. (TIMER)**



To access the function from the main menu (as indicated in the Menu section above), press the MENU button.

The menu items can be scrolled with the  and  buttons and the item can be entered with the  button.

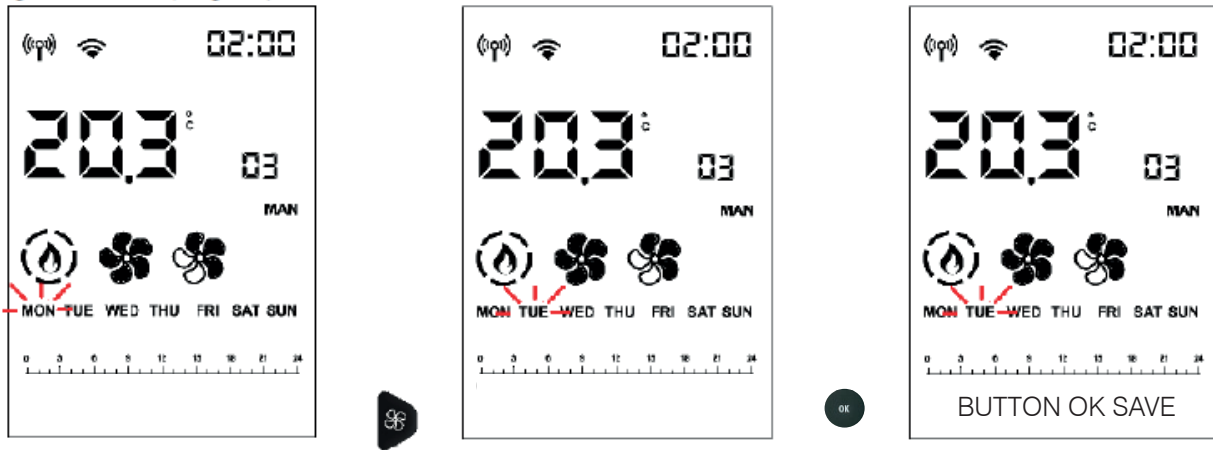
Choose the day of the week by scrolling the  and  buttons (you will simultaneously see the programme for that day) and confirm with the  button.



The cursor (rectangular and 2 pixels wide) positions itself on 00:00.  
 The time at the top RH shows the start of the time slot.  
 The word SET appears with the pre-set level for that time slot.

Use the  and  buttons to scroll the time with 1/2-hour steps, by moving the cursor and displaying the pre-set level.

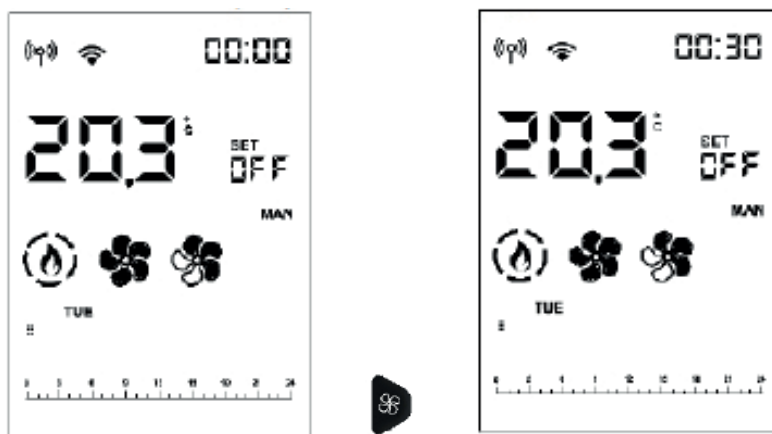

The **+** and **-** buttons can be used to modify the temperature levels (OFF – T1 and T2) or the power levels (OFF – P1 and P5).



After reaching 23:30 you must go backwards.

If you shift by pressing and holding the **+** and **-** buttons for more than 2", you copy the previous level onto the next level with a 1/2 h frequency per second. The level can be copied also with backward shifts.

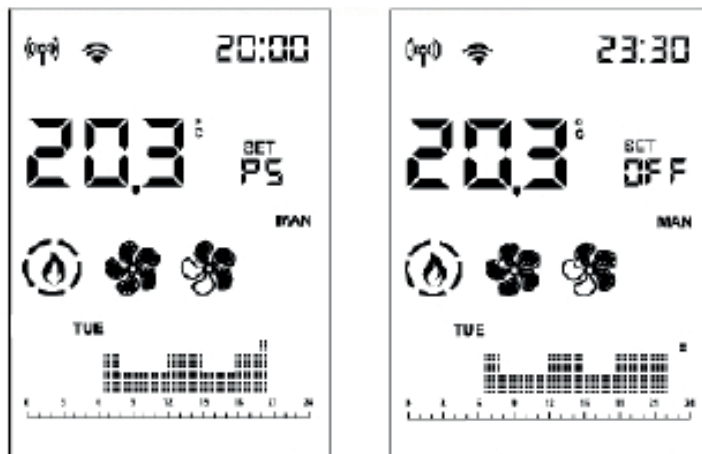

After setting the entire day, confirm with the following button **OK**

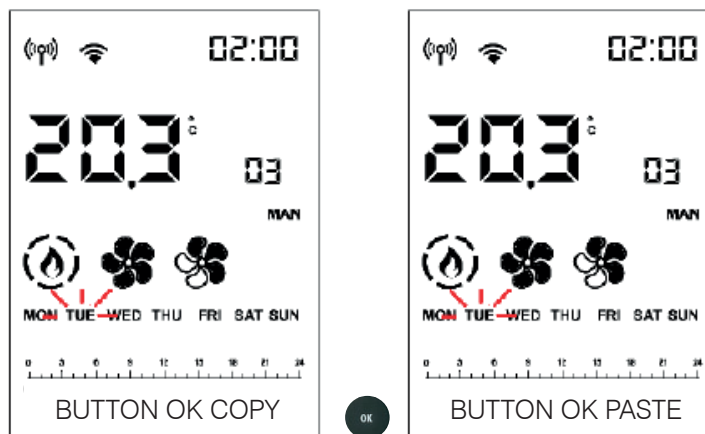



The day of the week will flash again and you can move to the next day



Confirm with the following button



Pressing the  button briefly allows you to exit the programming, but the programme will not activate.

To activate it, you must briefly press the button  again from the main page.

**NOTE**



The switching on and off of the product can be forced with the Timer active, by pressing the ON/OFF button for 2". Only if stand by is on the product switch on at the reached temperature.

**- TEMPERATURE SETTING FOR TIMER T1 - T2**

To access the function from the main menu (as indicated in the Menu section above), press the MENU button.

The menu items can be scrolled with the  and  buttons and the item can be entered with the  button.

After entering the T1-T2 function, the display will show the name of the function on the first line of the status bar and the current value of T1 on the second line. T1 is the lowest temperature, T2 the highest.

Use the  and  buttons to move to set-point T2 setting.

Modify the values with the  and  buttons and confirm with the  button.

Pressing the  button automatically takes you to the first level.

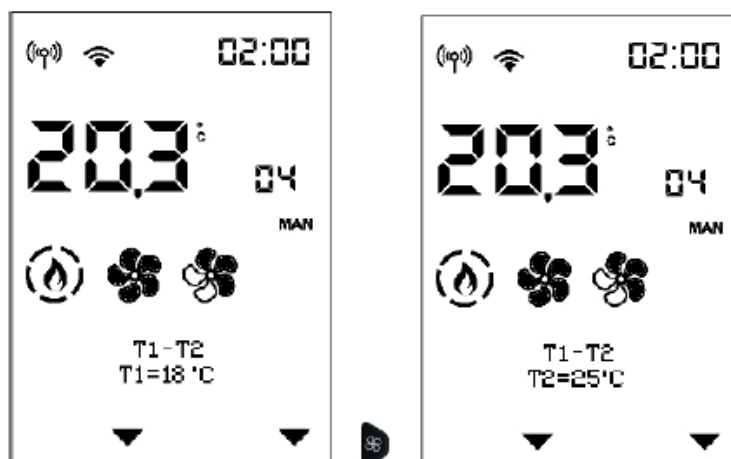



**- DATE AND HOUR (TIME)**

Can be used to set the current date and time.



To access the function from the main menu (as indicated in the Menu section above), press the MENU button.

The menu items can be scrolled with the  and  buttons and the item can be entered with the  button.

After entering the Date-Time function, the display will show the name of the function on the first line of the status bar and the current value of the first setting (12/24 hours) on the second line.

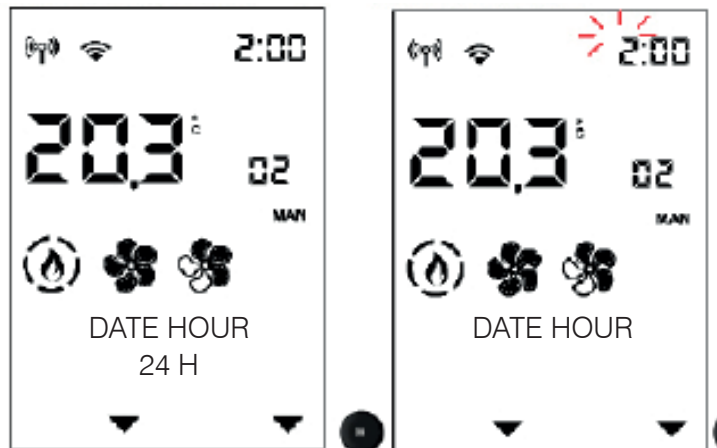
You can move from 12 to 24 hours using the  and  buttons and confirm with the  button.



The hours will then flash and can be modified using the  and  buttons and confirmed with the  button.

The minutes will then flash.

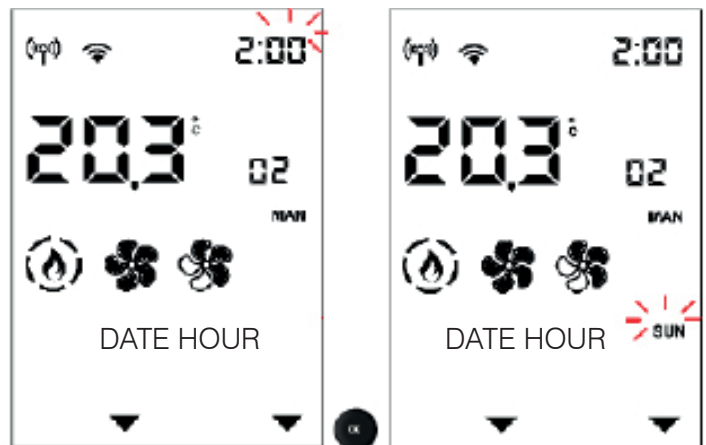

If the product is connected to the cloud, the date and time can be set from the Web and in the menu, after accessing the function, a message like “Date –Time from Web” will appear.

If the product is connected to a smartphone, the date and time can be set using the app.

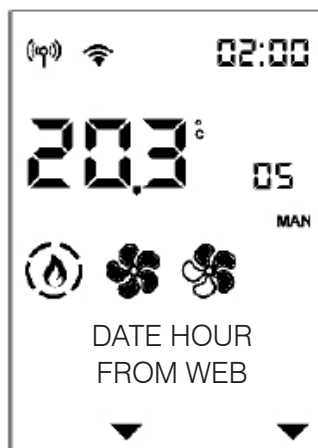





**- °C/°F SETTING  
of the temperature scale (centigrade or Fahrenheit degrees)**

To access the function from the main menu (as indicated in the Menu section above), press the MENU button.

You can scroll the menu items with the  and  buttons and enter the item with the following button .

After entering the °C/°F function, the name of the function appears on the first line of the status bar and the current value on the second line.



You can switch from °C to °F using the  and  buttons and then confirm with the  button and exit. Pressing the  button automatically takes you back to the first level.



**- LANGUAGE SETTING**



Selects the language.

To access the function from the main menu (as indicated in the Menu section above), press the MENU button.

You can scroll the menu items with the  and  buttons and enter the item with the following button .

After entering the Language Menu item, the name of the function appears on the first line of the status bar and the current value on the second line ITALIANO that means Italian.



You can modify the language with the  and  buttons, confirm and then exit with the following button . Pressing the OK button automatically takes you back to the first level.



**- DISPLAY**

It allows you to choose the background of the display,

**- INFO**

These readings should only be done when requested by the technician.  
The technician understands the diagnostic meaning of the messages and values, and may ask you to read them to him/her if you experience problems.

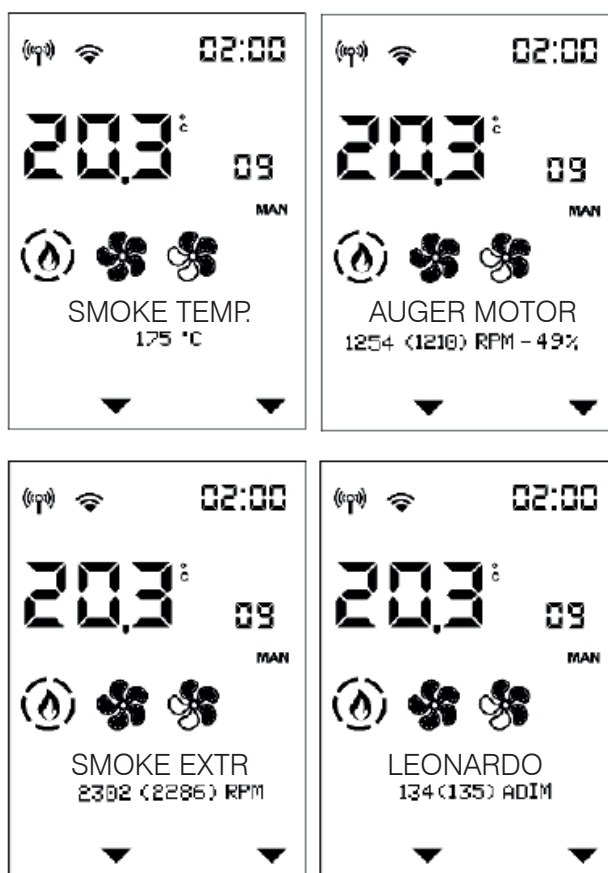

To access the function from the main menu (as indicated in the Menu paragraph above), press the MENU button.

You can scroll the menu items with the  and  buttons. 



Exit with the following button 

**- DATA**

Information of the product's operation log can be scrolled with the  and  buttons.

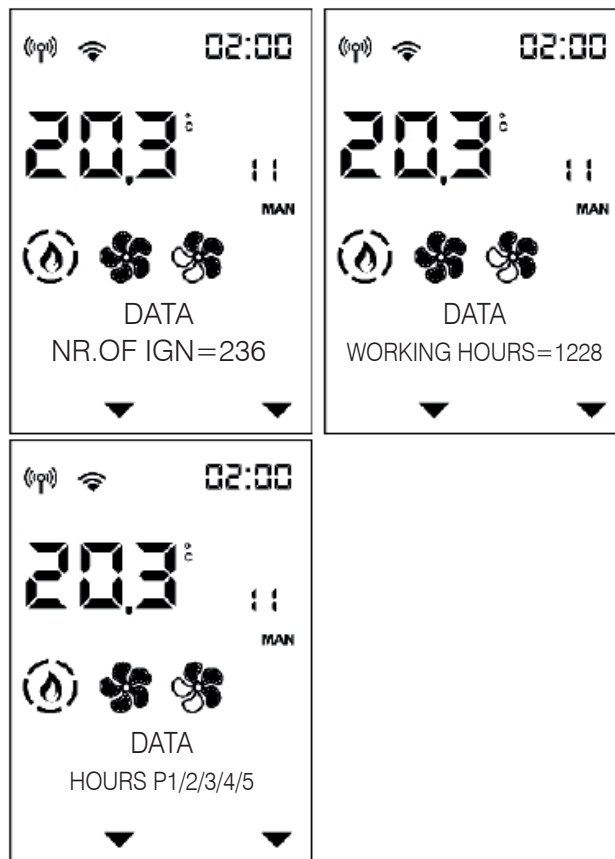

To access the function from the main menu (as indicated in the Menu paragraph above), press the MENU button.

The menu items can be scrolled with the  and  buttons and the item can be entered with the  button.



Exit with the following button 

**- ALARM LOG**

Information of the product's operation log can be scrolled with the  and  buttons.

The alarms are arranged from the most recent to the oldest.



Exit with the following button 

**- SCREW FEEDER ON-OFF FOR THE TECHNICIAN ONLY (ON INDICATION OF THE AFTER-SALES DEPARTMENT)**

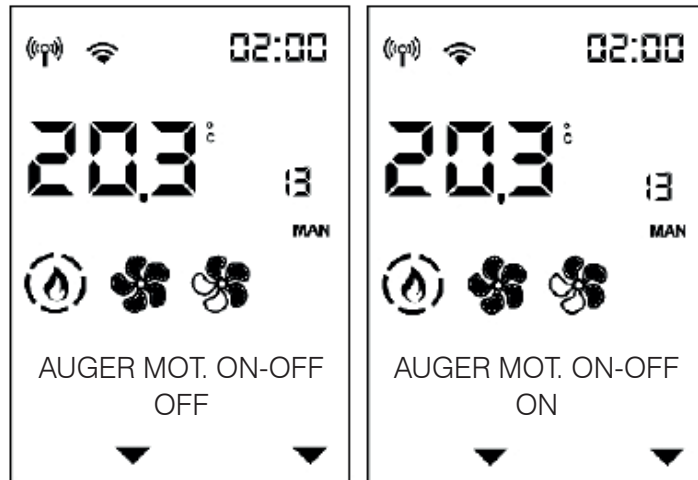

**- PELLET LEVEL SENSOR FOR THE TECHNICIAN (ENABLING)**

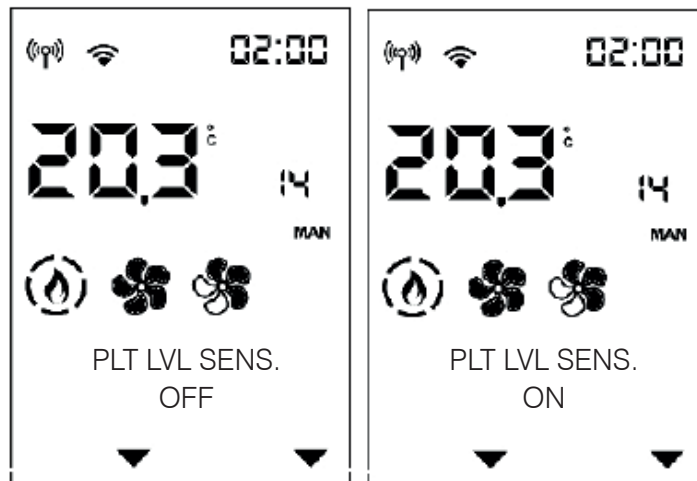

**- TECHNICAL MENU (for TECHNICIANS ONLY)**

Accessible only to an authorised technician with the appropriate password.

You must enter with the installer password (1111) and access the installer parameters/settings only

- Flame type (INST)
- Pellet type (INST)
- Chimney sweep function (INST)
- Cold test
- Parameters (INST)
- Reset hours
- Smoke probe correction



**NOTES**

inappropriate changes can cause the product to seize up

**- FLAME TYPE FOR THE TECHNICIAN**

After entering the Technical Menu the first item “FLAME TYPE” appears

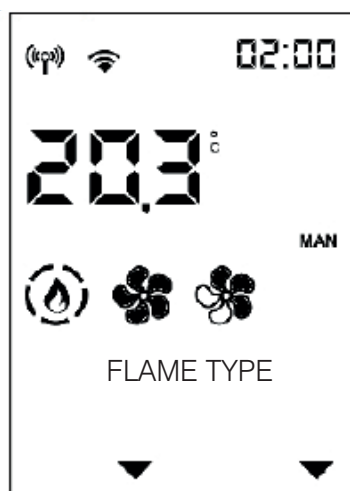

You can enter the Type of Flame setting with the 

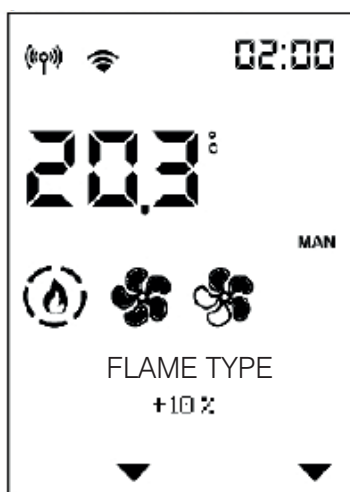

button and then modify the correction value with the  and  buttons.



Use the  button to exit and return to the Technical Menu

**- PELLET TYPE**

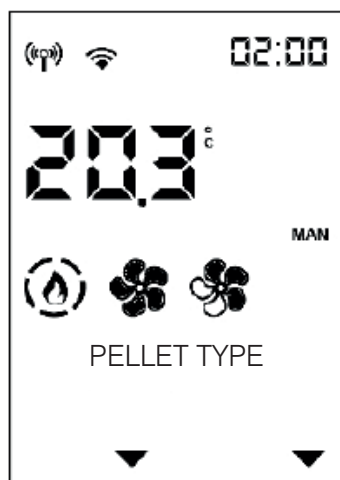
You can scroll the Technical Menu items with the  and  buttons until you reach "PELLET TYPE"





You can enter the Pellet Type setting with the following button 

and modify the value with the  and  buttons.

Use the  button to exit and return to the Technical Menu

**- CHIMNEY SWEEP FUNCTION (ONLY WITH THE PRODUCT ON)**

It can be used to conduct the requested checks agreed upon with the technician

Scroll between the Nominal (Max) or Minimum (Min) function using the  and  buttons and modify the value from OFF to ON with the  and  buttons.

Use the  button to confirm the value and return to the Technical Menu

If you confirm the ON value, the chimney sweep function activates, otherwise you can deactivate it.

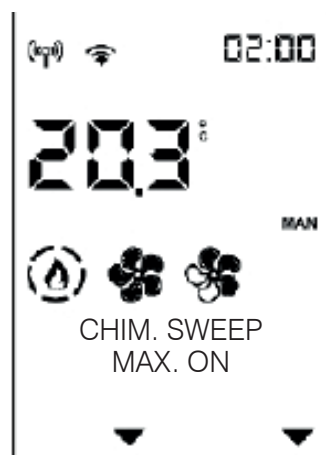
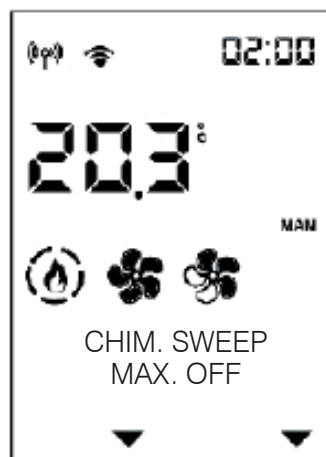
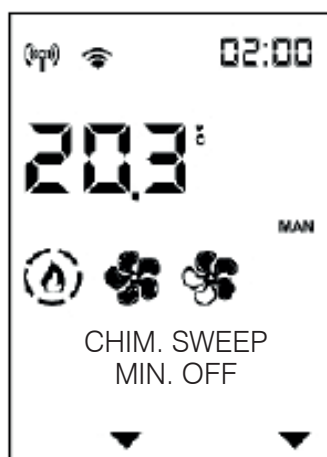



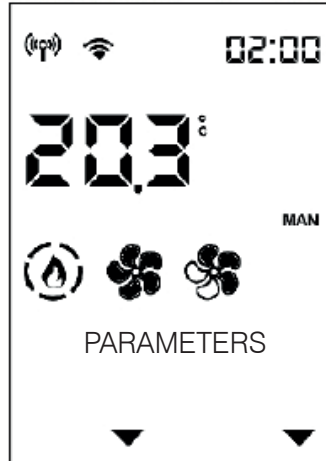

**- PARAMETERS**  
**PLEASE REFER SERVICE SUGGESTIONS**

You can scroll the Technical Menu items with the  and  buttons until you reach "PARAMETERS".

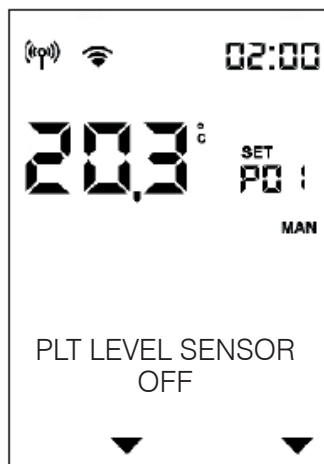

Enter the Parameters section with the  button: the first parameter will be displayed.



Scroll the parameters with the  and  buttons and modify the value with the  and  buttons.

If you entered the Technical Menu with the installer password, only the installer parameters will appear, otherwise all the other parameters will be shown.

Use the  button to exit the parameter modification section and return to the Technical Menu.



**SAVE PANEL**



SAVE PANEL can temporarily make up for the absence of a remote control or smartphone, or other product management systems.

Controls the product starting from the pressing of the buttons.

When the remote control or smartphone re-establishes the communication and sends a command to the product, the remote control or smartphone will once again resume control of the product.

The display will ONLY appear if the product is controlled via the SAVE PANEL.

**FUNCTIONS**









**To switch on the product:** press the On-Off button for a few seconds.

**To set the power level with the product on:** press the "power" button once. Pressing it repeatedly will cause the power to increase, with the following setting appearing on the display: "P1" – "P2" – "P3" – "P4" – "P5" – "P1" – "P2" – ... The ventilation of all room fans will automatically follow the product's power level without it being possible to adjust them.

**To switch off the product:** press the On-Off button for a few seconds.

**To unlock the product that has been locked due to an alarm:** press the On-Off button for a few seconds.

The three LEDs on the left indicate the status of the product associated with the display.

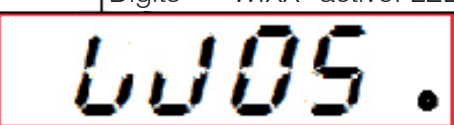
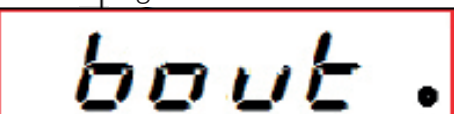
Panel without control unit	Active: LED1 (network present)	
Stove off	Digits = "OFF" active: LED1	
Stove being switched on	Digits = "ON" active: LED1 and LED2	
Stove running	Digits = "ON" active: LED1, LED2 and LED3	
Stove in cleaning mode in work mode	Digits = "ON" active: LED1, LED2, LED3 and LED4	
Stove cooling	Digits = "OFF" active: LED1 and LED2	
Stove cooling	Digits = "OFF". Active: LED1, LED2 and LED3	
Stove in alarm mode	Digits = "AL XX" active: LED1	
Stove in warning mode	Digits = "W:XX" active: LED1	
Stove off due to blackout	Digits = "bout" active: LED1	

**Before doing any maintenance, disconnect the appliance from the mains.  
Regular maintenance is essential to keep the appliance in good working order.  
Failure to service the product properly will prevent it from working properly.  
Any problems due to failure to service the stove will void the warranty.**

**DAILY MAINTENANCE**

These jobs should be done with the product off, cold and preferably disconnected from the mains.

A suitable vacuum cleaner is required.

The entire procedure takes just a few minutes.



**Using the stove without cleaning the burning pot can cause the gas in the combustion chamber to ignite....leading to burst/glass breakage.**

**DAILY MAINTENANCE**

**These jobs should be done with the product off, cold and preferably disconnected from the mains.**

A suitable vacuum cleaner is required.

The entire procedure takes just a few minutes.

1. Open the combustion chamber door (P) using the removable handle provided.
2. The burning pot (A) slips into position in its housing. Empty the ash tray (B) and burning pot into a non-flammable container (the ashes may still contain embers and/or hot parts) or vacuum if cold. Vacuum out the interior of the combustion chamber, the bed, and the compartment around the burning pot into which the ash falls.
3. Scrape the burning pot and clean out any obstructed holes.
4. If necessary, clean the glass when cold using a dedicated product (e.g. Glasskamin), which your dealer should have.

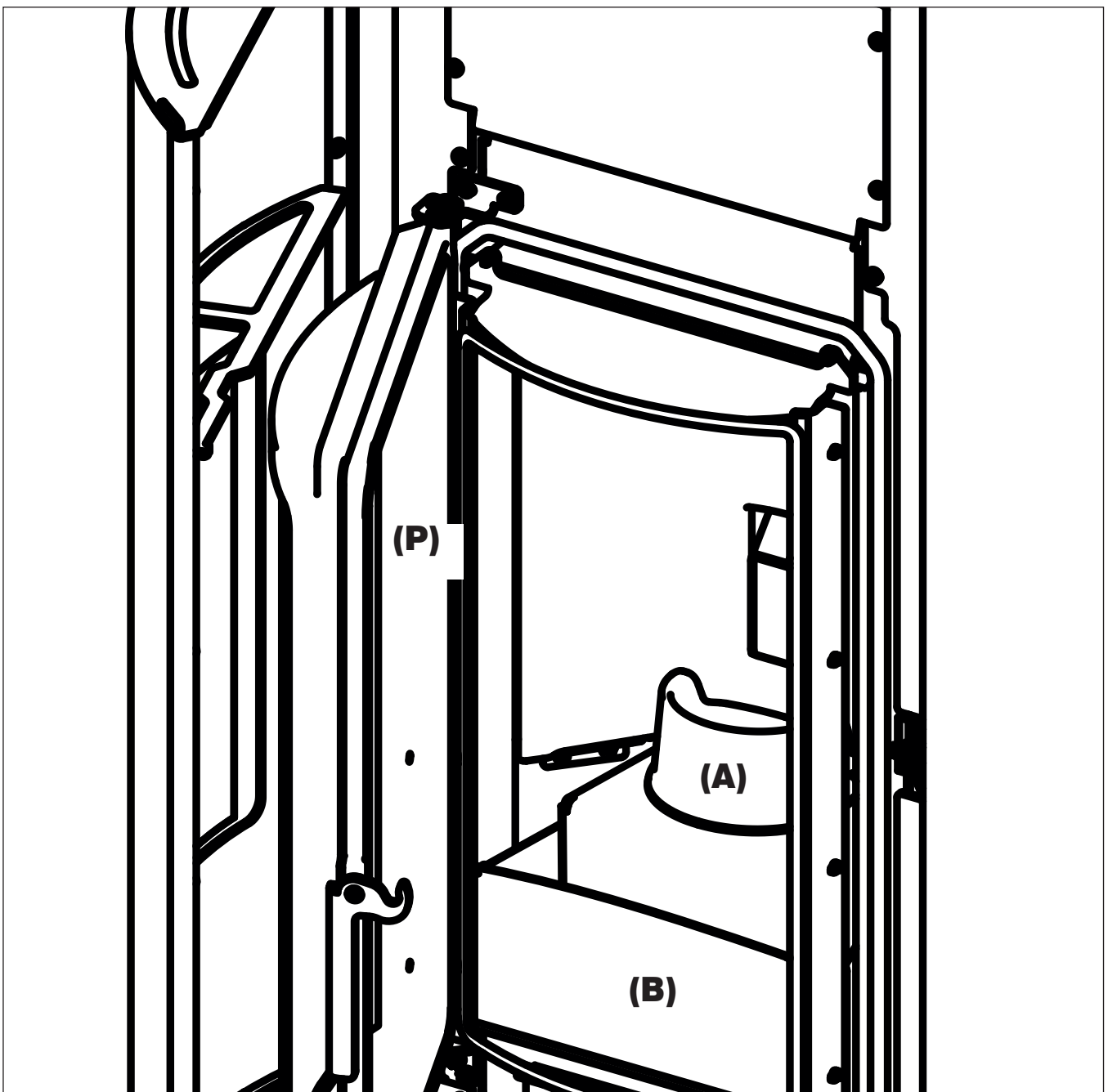

**SEASONAL MAINTENANCE  
(implemented by the DEALER)**

Clean the stove internally and externally

**In the event of very frequent use of the oven, it is advised cleaning of the smoke passage duct and smoke channel every 3 months.**

You should clean the chimney system at least once a year (check local regulations for details).

If you fail to regularly clean and inspect the system, there is an increased risk of the chimney pot catching fire.

We remind you not to use compressed air during the seasonal maintenance for cleaning the air inlet pipe.

**Seasonal maintenance should be performed by a qualified technician in accordance with the national and local regulations.**

**SUMMER SHUTDOWN**

During the period of disuse, keep the stoves doors, hatches and lids closed.

We recommend emptying out the pellet tank.

**SPARE PARTS**

For any spare parts, contact your reseller or technician.

Using non-original spare parts may damage the appliance and relieves Edilkamin of all liability for damage resulting therefrom.

**DISPOSAL**

At the end of its service life, dispose of the product as required by regulations.

Deliver to the special recycling centres.



In accordance with art. 26 of Legislative Decree no. 49 of 14th March 2014, "Implementation of Directive 2012/19/UE on the disposal of electrical and electronic devices (RAEE)".

The crossed-out dustbin symbol displayed on equipment or its packaging indicates that the product at the end of its life must be collected separately from other waste.

At the end of its useful life, the user should therefore deliver the product to a suitable local sorted collection centre for electrical and electronic devices.

Sorted collection for recycling, treatment and environmentally compatible scrapping contributes to the prevention of negative effects on the environment and health, and promotes the re-use and recycling of the materials of which the equipment is made.

If problems occur, the product shuts itself off automatically.

The display will show the reason (see below).

Do not disconnect from the power supply.

To restart the product, wait for the switch-off sequence to terminate and then press the ON/OFF button  of the remote control or the simplified switch-on button.

Before starting the product up again, check the reason for the shutdown and CLEAN the burning pot.

The product is equipped with the necessary safety devices but, if the burning pot is not cleaned regularly as explained above, ignition may involve a slight detonation. If white smoke forms in the combustion chamber for a long time, disconnect the mains supply and wait 30 minutes before opening the door and emptying out the burning pot.

**SHUTDOWN MESSAGES AND THEIR SOLUTIONS:**

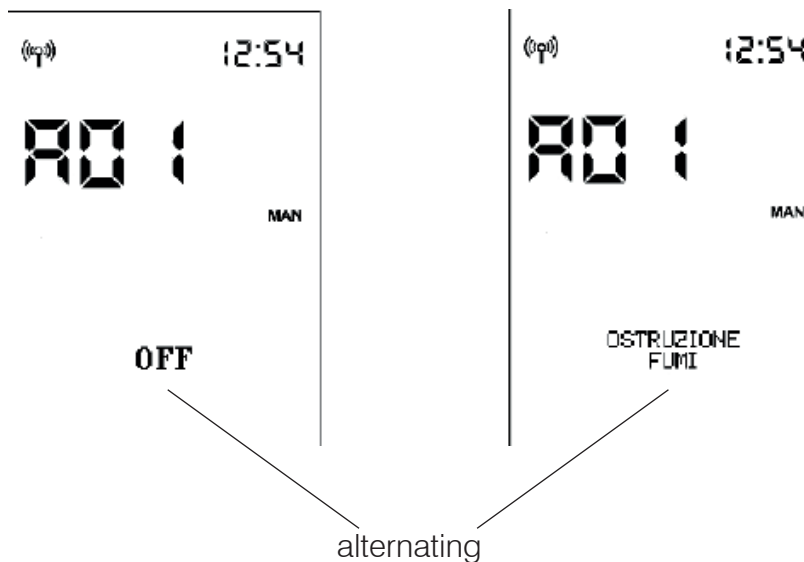

In case of an alarm, an alarm code will appear instead of the room temperature.

While the product switches off, the status bar will alternately show "OFF" in large letters and the description of the alarm in small letters.

If the alarm occurred with the timer active, only the timer's activation arrow will remain displayed, while the day's time schedule will disappear.

Once the switch-off sequence terminates, only the alarm description will remain.

MESSAGE	PROBLEM	SOLUTION
<b>A01</b>	displays when the combustion air intake is below the set level	<ul style="list-style-type: none"> <li>• Check that the combustion chamber door is closed</li> <li>• Check the regular maintenance of the product</li> <li>• Check that smoke discharge and combustion air ducts are clean.</li> </ul>
<b>A02</b>	displays when the logic board is not detecting the right fumes fan speed	<ul style="list-style-type: none"> <li>• Contact the technician</li> </ul>
<b>A03</b>	displays when the thermocouple detects a fume temperature lower than the set value and interprets this as the absence of flame	<ul style="list-style-type: none"> <li>• Check that there are pellets in the tank</li> <li>• Contact the technician</li> </ul>
<b>A04</b>	displays when ignition times out unsuccessfully	<p>There are two possibilities: NO flame:</p> <ul style="list-style-type: none"> <li>• Check that the burning pot is seated properly and clean</li> <li>• Check that there are pellets in the tank and burning pot</li> <li>• Try switching it on with a solid ecological igniter (contact the technician beforehand and follow the instructions of the igniter supplier very carefully).</li> </ul> <p>The operation must be regarded purely as a trial under the technician's guidance.</p>
<b>A05</b>	Shutdown due to air flow rate sensor breakage	<ul style="list-style-type: none"> <li>• Contact the technician</li> </ul>
<b>A06</b>	displays when the logic board determines that the fumes thermocouple is broken or disconnected	<ul style="list-style-type: none"> <li>• Contact the technician</li> </ul>
<b>A07</b>	Shut-down due to exceeding maximum fumes temperature.	<ul style="list-style-type: none"> <li>• Check the type of pellet (contact the technician if in doubt)</li> <li>• contact the technician</li> </ul>
<b>A08</b>	Switching OFF due to excessive overheating of the product	<ul style="list-style-type: none"> <li>• see A07</li> </ul>
<b>A09</b>	Shutdown due to gearmotor failure.	<ul style="list-style-type: none"> <li>• Contact the technician</li> </ul>
<b>A10</b>	Switching OFF due to circuit board overheating.	<ul style="list-style-type: none"> <li>• Contact the technician</li> </ul>
<b>A11</b>	Switching OFF due to the intervention of the safety pressure switch.	<ul style="list-style-type: none"> <li>• Ensure the product and flue are clean</li> <li>• Contact the technician</li> </ul>

<b>MESSAGE</b>	<b>PROBLEM</b>	<b>SOLUTION</b>
<b>A12</b>	Room temperature probe failure. The product is operating in manual mode.	<ul style="list-style-type: none"> <li>• Contact the technician</li> </ul>
<b>A14</b>	Ducting room temperature probe (if present) fault. The product is operating in manual mode.	<ul style="list-style-type: none"> <li>• Contact the technician</li> </ul>
<b>A20</b>	Gearmotor fault switch-off	<ul style="list-style-type: none"> <li>• Contact the technician</li> </ul>



**MESSAGES WHICH DO NOT SHUT THE STOVE DOWN, BUT ARE SIMPLY WARNINGS**

**LOW REMOTE CONTROL BATTERY LEVEL:**

The battery symbol displays on the remote control display if the battery is low.

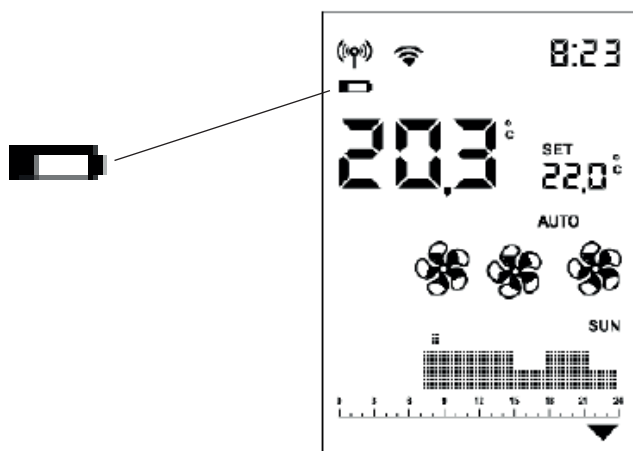

**MAINTENANCE:**

A spanner symbol will appear on the display after 2,000 hours of operation.

The product is working, but it must be serviced by an authorised Edilkamin technician.

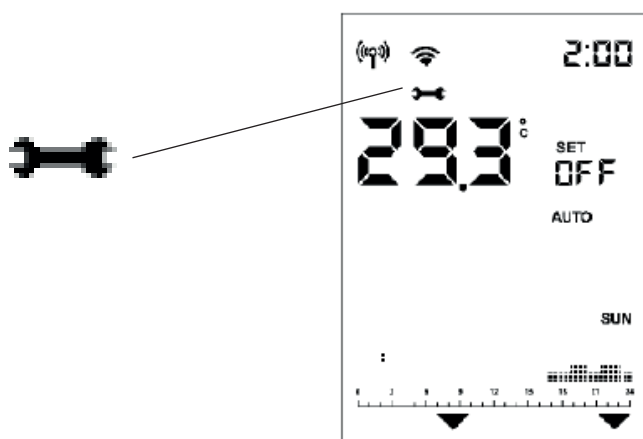

**LACK OF COMMUNICATION:**

In case of a prolonged lack of communication between the stove and the remote control, the Bluetooth transmission icon  will disappear as well as the icons transmitted by the circuit board to the remote control. Only the room temperature and the time will remain visible.



The Wi-Fi transmission icon will only be present if there is a connection between the circuit board and the Wi-Fi router.

**PELLETS RESERVE INDICATOR:**

The function is only available if the pellet level sensor is installed and has been activated.

When the level sensor intervenes, the circuit board emits a single “beep” (in any switch-on or work status) and the moving reserve symbol will appear on the display.

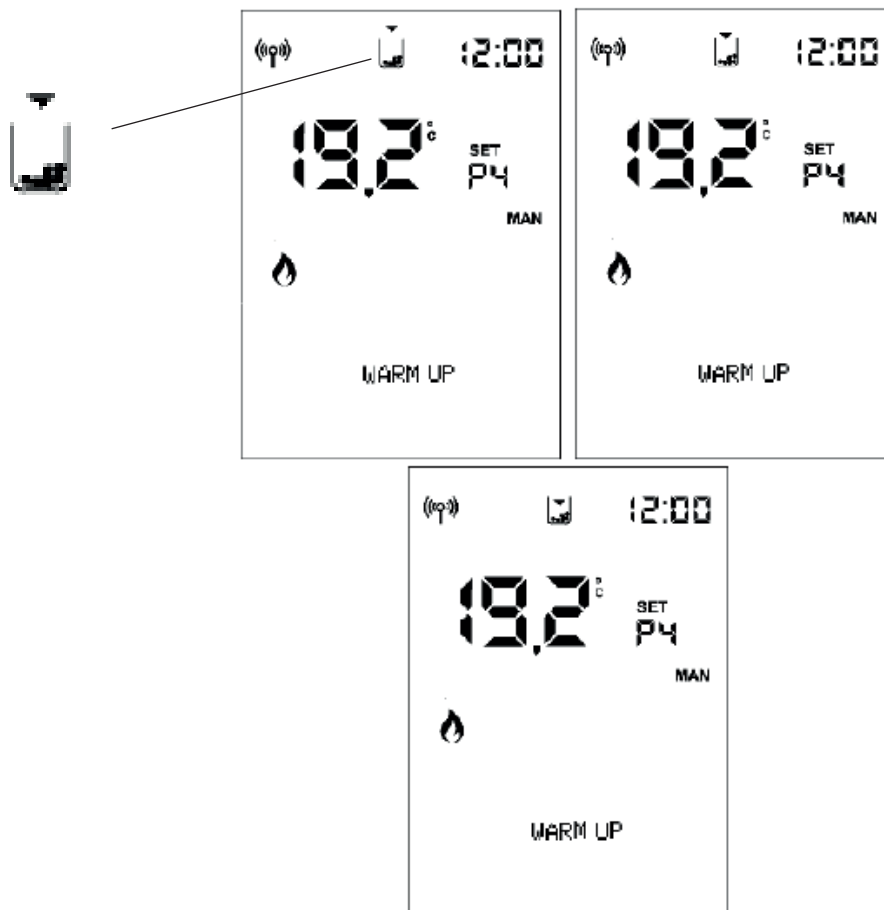

The arrows will light up in sequence to signal the need for pellet loading.

The ignition frequency is roughly 0.5 seconds.

After an interval of roughly 20/30 minutes, which varies depending on the model, the stove switches off due to a shortage of pellets.

If the user reloads the stove before the start of the switch-off procedure, the symbol disappears and the stove resumes its normal operation.

If the user fails to reload the stove before the start of the switch-off procedure, the stove switches off and the tank symbol remains steady lit with the 3 arrows on until the next reloading operation.

When the reserve symbol is present, the stove cannot be restarted.

After reloading the pellets, the stove must be restarted manually.

If the pellets are reloaded and there is an ignition request coming from the timer, the stove will restart.

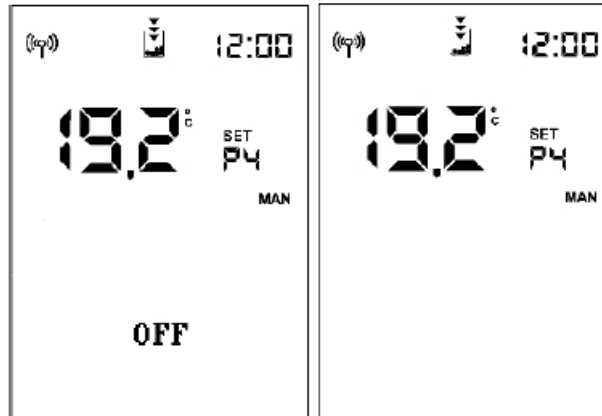

If the sensor intervenes:

- with the stove OFF or in Initial Cleaning mode (following manual emptying of the tank), the final symbol will immediately appear and the stove cannot be switched on;
- during the ignition phase, the ignition sequence will be completed even if it lasts more than the 20/30 minutes of residual autonomy.

If the pellets are not reloaded, the stove will then switch off.

During a switch-off following a **BLACKOUT**, the display will alternately show the words “Black-Out” and “OFF”. Once the switch-off has been completed, the product will remain off and “Black-Out” will appear.

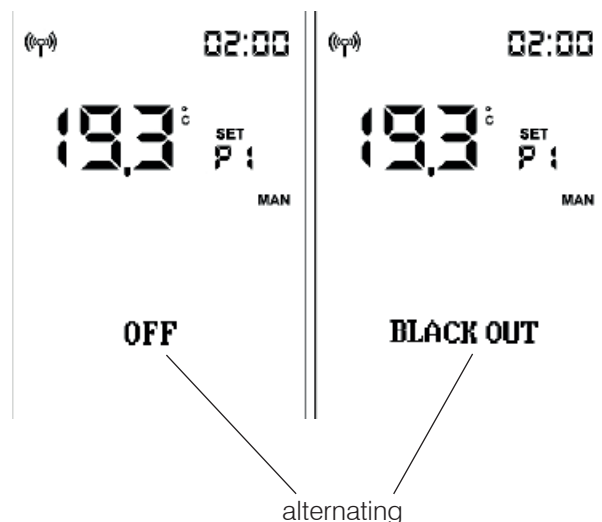



**EDILKAMIN**  
TECNOLOGIA DEL FUOCO

[www.edilkamin.com](http://www.edilkamin.com)

cod. 942171-GB 10.21/A