

CHERIE 9 EVO ATC
CHERIE 9 EVO AT
CHERIE 11 EVO ATC
CHERIE 11 EVO AT

PELLET STOVE



For all updates visit www.edilkamin.com

The original language of this manual is Italian

The undersigned, EDILKAMIN S.p.A., with registered office in Via P. Moscati 8 - 20154 Milan (Italy) - Tax ID Code and VAT number 00192220192

Hereby declares, under its sole responsibility, that: the pellet stoves mentioned below comply with Regulation (EU) No. 305/2011 and the harmonised European standard EN 14785:2006

PELLET STOVES, bearing the EDILKAMIN trademark, named

SERIAL NO.: Rating plate reference
CHERIE 9 EVO ATC/ CHERIE 9 EVO AT
Declaration of Performance (DoP - EK no. 234)
CHERIE 11 EVO ATC/ CHERIE 11 EVO AT
Declaration of Performance (DoP - EK no. 235)

Moreover, the company hereby declares that: the above-mentioned wood-burning pellet stoves satisfy the requirements of the following European directives:
2014/35/EU - Low Voltage Directive
2014/30/EU - Electromagnetic Compatibility Directive
2011/65/EU - RoHS2 Directive on the restriction of the use of certain hazardous substances in electrical and electronic equipment
2009/125/EC - Ecodesign
2010/30/EU - Labelling

Dear Sir/Madam,
thank you for choosing our product and congratulations on your choice. Before using it, we kindly ask you to read this manual carefully, so that you can make the most of all its functions in total safety.

This manual is an integral part of the product. We ask you to keep it for the entire lifetime of the product. If you lose it, you can request a copy from your dealer or download it from www.edilkamin.com

Readers of this manual

This manual is addressed to:

- those who will use the product at home ("USER");
- the technician who will install the product ("INSTALLER").

The target person of each page is indicated in a band at the bottom of the page (USER/INSTALLER).

General information

After unpacking the product, check the condition and completeness of the contents.

If you find any anomalies, immediately contact the retailer where the purchase was made, providing them with a copy of the warranty certificate and the sales receipt.

The appliance must be correctly sized, installed, maintained and operated in compliance with local and national law and with European regulations. For the installation process, and for anything not specifically indicated in the manual, the local regulations apply.

The diagrams provided in this manual are for illustration purposes only: they do not always strictly refer to your specific model, and are not binding in any way.

Identification of the product and warranty.

The product is uniquely identified by a number, its serial number (counterfoil) which can be found on:

- the warranty certificate;
- the CE plate.

Please keep:

- the warranty certificate accompanying the product;
- the purchase receipt given to you by the retailer;
- the declaration of conformity (or the documents required in the country of installation) issued to you by the installer.

The warranty conditions are given in the warranty certificate accompanying the product and on the website www.edilkamin.com.



MEANING OF SYMBOLS

In some parts of the manual the following symbols are used:



PLEASE NOTE:

carefully read and understand the message in question, since failure to follow the instructions in it could cause serious damage to the product and put the safety of those using it at risk.



INFORMATION:

failure to comply with these requirements will compromise product use.



OPERATING SEQUENCE:

follow the instructions for the operations described.

The product's CE marking plate is located on the back.

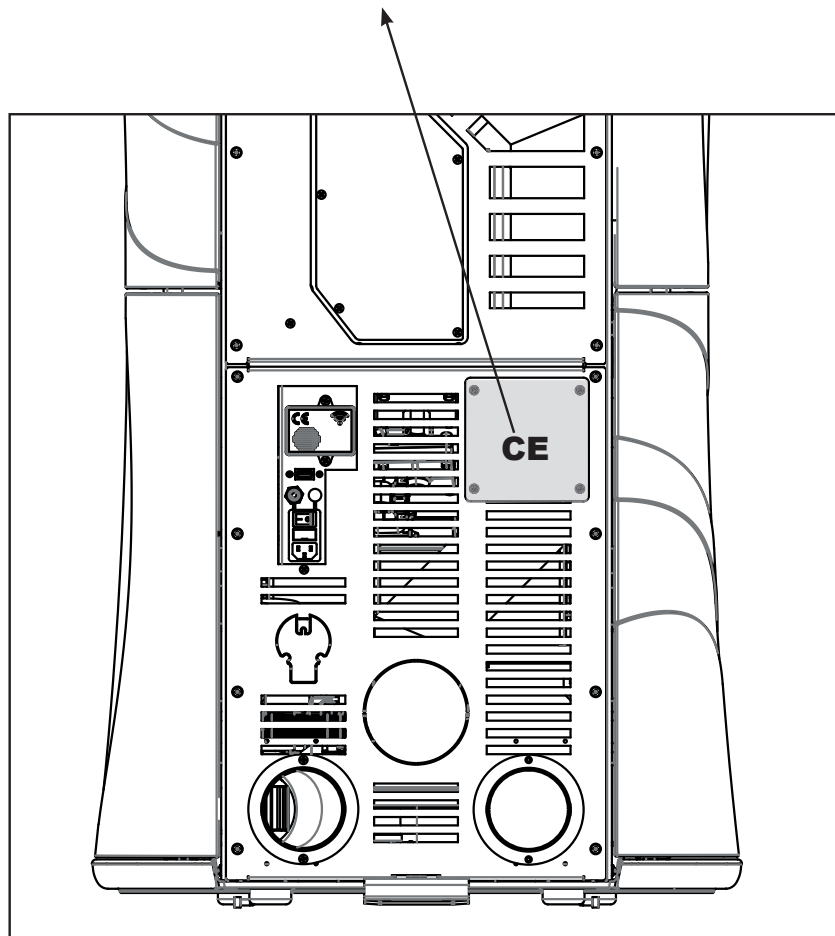

- The product is not designed for use by people, including children, with limited physical, sensory and mental abilities.
- The appliance is not designed for cooking purposes.
- The appliance is designed to burn UNI EN ISO 17225-2 category A1 wood pellets, in the amounts and manner described in this manual.
- The appliance is designed for indoor use and in areas with normal humidity conditions.
- Keep the product in a dry place out of the weather.
- For the legal and company warranties, refer to the warranty certificate inside the product: specifically, neither Edilkamin nor the retailer are liable for damage resulting from incorrect installation or maintenance.

Safety risks may be caused by:

- installation in non-suitable settings, in particular those that are subject to fire risks. **DO NOT INSTALL THE PRODUCT IN AREAS SUBJECT TO THE risk of fire.**
- contact with fire and hot parts (e.g. glass panel and pipes). **DO NOT TOUCH HOT PARTS** and, when the stove is switched off and still hot, always wear the glove.
- contact with live electrical equipment (internal). **DO NOT ACCESS THE INTERNAL ELECTRICAL EQUIPMENT WHILE THE APPLIANCE IS POWERED ON.** Electrocutation hazard.
- use of improper ignition aids (e.g. alcohol). **DO NOT IGNITE OR BOOST THE FLAME WITH FLUID SPRAYS OR A FLAME TORCH.** Serious risk of burns, damage and injury.
- use of fuel other than wood pellets. **DO NOT BURN WASTE MATTER, PLASTIC OR MATERIALS OTHER THAN WOOD PELLETS IN THE COMBUSTION CHAMBER.** The product may become soiled, the flue may catch fire, and environmental damage may ensue.
- cleaning of the combustion chamber when hot. **DO NOT CLEAN THE COMBUSTION CHAMBER WITH A VACUUM CLEANER WHILE IT IS HOT.** You could damage the vacuum cleaner and risk letting smoke into in the room.
- cleaning of the fume duct with various substances. **DO NOT ATTEMPT HOME-GROWN CLEANING SOLUTIONS USING INFLAMMABLE PRODUCTS.** Risk of fire or blowback.
- cleaning of the glass while hot or using unsuitable cleaning products. **DO NOT CLEAN HOT GLASS WITH WATER. ONLY USE RECOMMENDED GLASS CLEANING PRODUCTS.** There is a risk of cracking and permanent irreparable damage to the glass.
- storage of flammable materials at a distance below the safety distances specified in this manual. **DO NOT PLACE LAUNDRY ON THE APPLIANCE. DO NOT PLACE DRYING RACKS WITHIN THE SAFETY CLEARANCE.** Keep flammable fluids away from the appliance. Risk of fire.
- blocking of the aeration vents and air intakes in the room. **DO NOT BLOCK THE AERATION VENTS OR THE FLUE.** This may cause smoke to return into the room resulting in damages to property and personal injury.
- use of the product as a support or ladder. **DO NOT CLIMB ONTO THE PRODUCT OR USE IT AS A SUPPORT.** Risk of damage and injury.
- use of the stove with the combustion chamber door open. **DO NOT USE THE PRODUCT WITH ITS DOOR OPEN.**
- incandescent material projected following opening of the door. **DO NOT** throw incandescent material outside the appliance. Fire hazard.
- use of water in case of fire. **CALL THE AUTHORITIES** if a fire breaks out.



Connect the product to the electricity supply only after having completed its assembly and mounted the cladding. Otherwise there is a risk of having live electrical parts accessible.

For reasons of safety, read the user instructions included in this manual.

If you have doubts, please do not take any action, but contact the dealer or the installer.

The names of Edilkamin official authorised technical assistance centres (TAC) and distributors are available **ONLY** at www.edilkamin.com

DIMENSIONS (cm)

- **Cherie 9 Evo ATC** (A: possible ducted air outlet or diverter position)
- **Cherie 11 Evo ATC** (A/B)

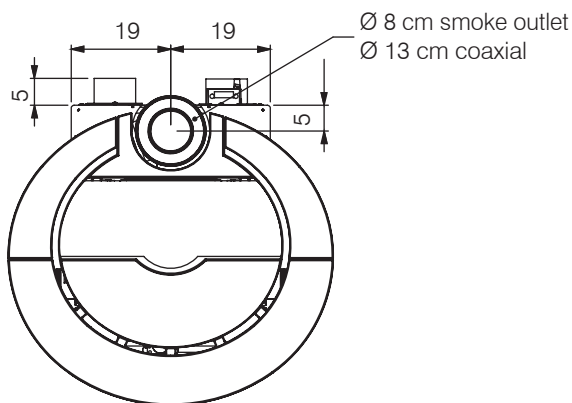
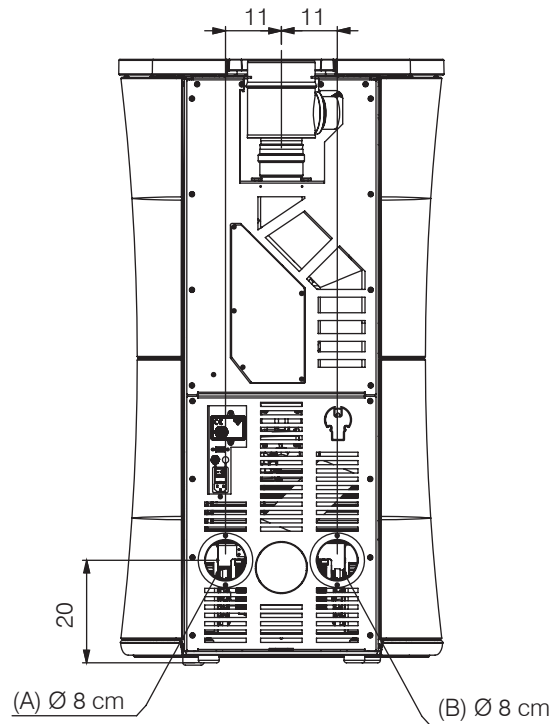
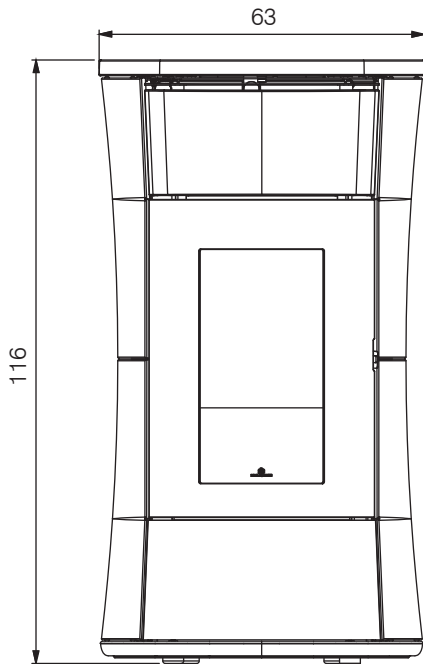

NOTE:

- The smoke outlet diameter does not match the chimney system diameter. The chimney system must be sized in accordance with the national and local regulations. In particular (this is not an exhaustive list), refer to the EN 13384, EN 1443, EN 1856, EN 1457 standards and to all local regulations.

DIMENSIONS (cm)

- **Cherie 9 Evo AT** (A: possible ducted air outlet or diverter position)
- **Cherie 11 Evo AT** (A/B)

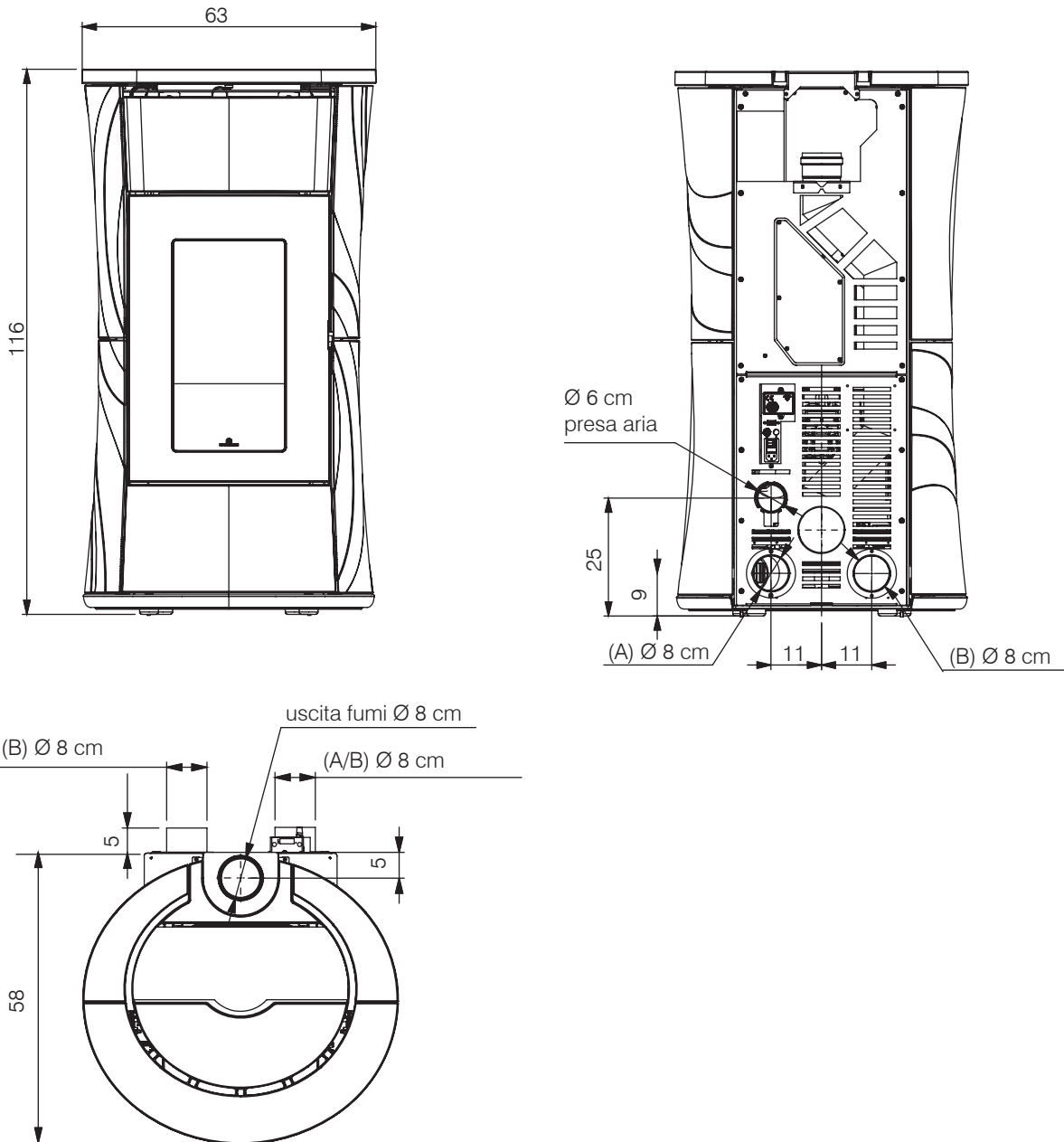

NOTE:

- The smoke outlet diameter does not match the chimney system diameter. The chimney system must be sized in accordance with the national and local regulations.

In particular (this is not an exhaustive list), refer to the EN 13384, EN 1443, EN 1856, EN 1457 standards and to all local regulations.

TECHNICAL CHARACTERISTICS pursuant to EN 14785 The data shown is purely indicative and was measured during the certification phase at a notified body under standard conditions.
The results were obtained with the glass cleaning system off. Use the gasket provided (to be done by the installer).

	CHERIE 9 EVO ATC/ CHERIE 9 EVO AT		
	Nominal power	Reduced power	
Available power	9	3,7	kW
Yield	89,2	93,1	%
CO emissions at 13% O ₂	0,004	0,006	%
Smoke temperature at smoke outlet	171	95,2	°C
Fuel consumption *	2	0,8	kg/h
Tank capacity	16		kg
Draw	11,1	10,1	Pa
Autonomy ***	9/23		hours
Heatable volume **	235		m ³
Smoke duct diameter	80		mm
Weight including packaging (steel/ceramic/soap stone)	216/218/250	--	kg
Energy efficiency class in accordance with EU regulation 2015-1186 (Classes A+ +/G)	A+	--	

* A calorific value of 4.8 kW/kg was used to calculate consumption.

** The heatable volume is calculated based on the assumption of a heating demand of 33 Kcal/m³ hour.

*** The autonomy may vary in relation to the usage/installation/fuel characteristics and is not contractually binding nor can it constitute grounds for dispute.

*** Accessories for ducting hot air are available.

The product can work safely even with greater draught.

Excessive draught could cause the product to switch off and/or lower its performance.

NOTE: the smoke outlet diameter does not match the chimney system diameter, which must be sized accordingly.

TECHNICAL DATA FOR SIZING THE FLUE			
which must in any case satisfy the requirements of this sheet and the installation instructions			
	Nominal power	Reduced power	
Smoke temperature at smoke outlet	205	114	°C
Minimum draught	0,001		Pa
Smoke flow rate	7,1	3,7	g/s
Firebox classification according to pr EN16510	CC 50		

ELECTRICAL SPECIFICATIONS	
Power supply	230 Vac +/- 10% 50 Hz
Nominal absorbed power	177 W
Reduced absorbed power	68 W
Absorbed power in stand-by mode	3 W
Power absorption during ignition	365 W
Remote control frequency (provided)	2.4 GHz
Protection rating	Fuse 4 AT 250 V AC 5x20

EDILKAMIN S.p.A. The manufacturer reserves the right to modify the product without notification in the interests of improvement.

TECHNICAL CHARACTERISTICS pursuant to EN 14785 The data shown is purely indicative and was measured during the certification phase at a notified body under standard conditions.
The results were obtained with the glass cleaning system off. Use the gasket provided (to be done by the installer).

	CHERIE 11 EVO ATC/ CHERIE 11 EVO AT		
	Nominal power	Reduced power	
Available power	11	3,7	kW
Yield	88,9	93,1	%
CO emissions at 13% O ₂	0,003	0,008	%
Smoke temperature at smoke outlet	194,5	95,2	°C
Fuel consumption *	2,5	0,8	kg/h
Tank capacity	16		kg
Draw	11,3	10,1	Pa
Autonomy ***	7/23		hours
Heatable volume **	295		m ³
Smoke duct diameter	80		mm
Weight including packaging (steel/ceramic/soap stone)	218/220/252	--	kg
Energy efficiency class in accordance with EU regulation 2015-1186 (Classes A+ +/G)	A+	--	

* A calorific value of 4.8 kW/kg was used to calculate consumption.

** The heatable volume is calculated based on the assumption of a heating demand of 33 Kcal/m³ hour.

*** The autonomy may vary in relation to the usage/installation/fuel characteristics and is not contractually binding nor can it constitute grounds for dispute.

*** Accessories for ducting hot air are available.

The product can work safely even with greater draught.

Excessive draught could cause the product to switch off and/or lower its performance.

NOTE: the smoke outlet diameter does not match the chimney system diameter, which must be sized accordingly.

TECHNICAL DATA FOR SIZING THE FLUE			
which must in any case satisfy the requirements of this sheet and the installation instructions			
	Nominal power	Reduced power	
Smoke temperature at smoke outlet	233	114	°C
Minimum draught	0,01		Pa
Smoke flow rate	7,6	3,7	g/s
Firebox classification according to pr EN16510	CC 50		

ELECTRICAL SPECIFICATIONS	
Power supply	230 V AC +/- 10% 50 Hz
Nominal absorbed power	126 W
Reduced absorbed power	23 W
Absorbed power in stand-by mode	3 W
Power absorption during ignition	365 W
Remote control frequency (provided)	2.4 GHz
Protection rating	Fuse 4 AT 250 V AC 5x20

EDILKAMIN S.p.A. The manufacturer reserves the right to modify the product without notification in the interests of improvement.



Inclusa nell'albo dei laboratori altamente qualificati, autorizzati dal Ministero dell'Università e della Ricerca Scientifica e Tecnologica ex art. 4 legge n. 46/92 (D.M. 25 maggio 1999)

**ECODESIGN REQUIREMENTS FOR LOCAL SPACE HEATERS
ACCORDING TO DIRECTIVE 2009/125/EC OF THE
EUROPEAN PARLIAMENT AND OF THE COUNCIL
- COMMISSION REGULATION (EU) 2015/1185 -**

EDILKAMIN – CHERIE 9 EVO ATC, CHERIE 9 EVO AT
Indirect heating functionality: NO
Direct heat output: 9,0 kW (space heat output)
Indirect heat output: -- kW (water heat output)

Fuel	Preferred fuel (only one):	Other suitable fuel(s):	η_{fs} [%]:	Space heating emissions at nominal heat output(*)				Space heating emissions at minimum heat output(**)					
				PM	OGC	CO	NOx	PM	OGC	CO	NOx		
				mg/m ³ at 13%O ₂				mg/m ³ at 13%O ₂					
Log wood, moisture content ≤ 25 %	no	no											
Compressed wood with moisture content < 12 %	yes	no	84,6	6	<1	55	90	15	<1	106	80		
Other woody biomass	no	no											
Non-woody biomass	no	no											
Anthracite and dry steam coal	no	no											
Hard coke	no	no											
Low temperature coke	no	no											
Bituminous coal	no	no											
Lignite briquettes	no	no											
Peat briquettes	no	no											
Blended fossil fuel briquettes	no	no											
Other fossil fuel	no	no											
Blended biomass and fossil fuel briquettes	no	no											
Other blend of biomass and solid fuel	no	no											

Characteristics when operating with the preferred fuel only:

Seasonal space heating energy efficiency η_{fs} [%]: **84,6**

Energy efficiency index EEI: **125**

Energy efficiency class: **A+**

Item	Symbol	Value	Unit	Item	Symbol	Value	Unit
Heat output				Useful efficiency (NCV as received)			
Nominal heat output	P_{nom}	9,0	kW	Useful efficiency at nominal heat output	$\eta_{th,nom}$	89,2	%
Minimum heat output (indicative)	P_{min}	3,7	kW	Useful efficiency at minimum heat output (indicative)	$\eta_{th,min}$	93,1	%
Auxiliary electricity consumption				Type of heat output/room temperature control (select one)			
At nominal heat output	el_{max}	0,177	kW	single stage heat output, no room temperature control		NO	
At minimum heat output	el_{min}	0,068	kW	two or more manual stages, no room temperature control		NO	
In standby mode	el_{sb}	0,003	kW	with mechanic thermostat room temperature control		NO	
Permanent pilot flame power requirement				with electronic room temperature control		NO	
Pilot flame power requirement (if applicable)	P_{pilot}	N.A.	kW	with electronic room temperature control plus day timer		NO	
				with electronic room temperature control plus week timer		YES	
				Other control options (multiple selections possible)			
				room temperature control, with presence detection		NO	
				room temperature control, with open window detection		NO	
				with distance control option		YES	

Contact details	Name and address of the manufacturer or its authorized representative.
Tel. +39 02 937621 www.edilkamin.it mail@edilkamin.it	Manufacturer: EDILKAMIN SPA Via Mascagni 7 20020 Lainate (MI) – ITALY

(*) PM = particulate matter, OGCs = organic gaseous compounds, CO = carbon monoxide, NO_x = nitrogen oxides

(**) Only required if correction factors F(2) or F(3) are applied.



Inclusa nell'albo dei laboratori altamente qualificati, autorizzati dal Ministero dell'Università e della Ricerca Scientifica e Tecnologica ex art. 4 legge n. 46/82 (D.M. 25 maggio 1990)

**ECODESIGN REQUIREMENTS FOR LOCAL SPACE HEATERS
ACCORDING TO DIRECTIVE 2009/125/EC OF THE
EUROPEAN PARLIAMENT AND OF THE COUNCIL
- COMMISSION REGULATION (EU) 2015/1185 -**

EDILKAMIN – CHERIE 11 EVO ATC, CHERIE 11 EVO AT
Indirect heating functionality: NO
Direct heat output: 11,0 kW (space heat output)
Indirect heat output: -- kW (water heat output)

Fuel	Preferred fuel (only one):	Other suitable fuel(s):	η_s [%]:	Space heating emissions at nominal heat output(*)				Space heating emissions at minimum heat output(**)			
				PM	OGC	CO	NOx	PM	OGC	CO	NOx
				mg/m ³ at 13%O ₂				mg/m ³ at 13%O ₂			
Log wood, moisture content ≤ 25 %	no	no									
Compressed wood with moisture content < 12 %	yes	no	84,6	4	<1	42	95	15	<1	106	80
Other woody biomass	no	no									
Non-woody biomass	no	no									
Anthracite and dry steam coal	no	no									
Hard coke	no	no									
Low temperature coke	no	no									
Bituminous coal	no	no									
Lignite briquettes	no	no									
Peat briquettes	no	no									
Blended fossil fuel briquettes	no	no									
Other fossil fuel	no	no									
Blended biomass and fossil fuel briquettes	no	no									
Other blend of biomass and solid fuel	no	no									

Characteristics when operating with the preferred fuel only:

Seasonal space heating energy efficiency η_s [%]: **84,6**

Energy efficiency index EEI: **125**

Energy efficiency class: **A+**

Item	Symbol	Value	Unit	Item	Symbol	Value	Unit
Heat output				Useful efficiency (NCV as received)			
Nominal heat output	P_{nom}	11,0	kW	Useful efficiency at nominal heat output	$\eta_{th,nom}$	88,9	%
Minimum heat output (indicative)	P_{min}	3,7	kW	Useful efficiency at minimum heat output (indicative)	$\eta_{th,min}$	93,1	%
Auxiliary electricity consumption				Type of heat output/room temperature control (select one)			
At nominal heat output	$e_{l,max}$	0,220	kW	single stage heat output, no room temperature control		NO	
At minimum heat output	$e_{l,min}$	0,068	kW	two or more manual stages, no room temperature control		NO	
In standby mode	$e_{l,SB}$	0,003	kW	with mechanic thermostat room temperature control		NO	
Permanent pilot flame power requirement				with electronic room temperature control		NO	
Pilot flame power requirement (if applicable)	P_{pilot}	N.A.	kW	with electronic room temperature control plus day timer		NO	
				with electronic room temperature control plus week timer		YES	
				Other control options (multiple selections possible)			
				room temperature control, with presence detection		NO	
				room temperature control, with open window detection		NO	
				with distance control option		YES	
Contact details	Name and address of the manufacturer or its authorized representative.						
Tel. +39 02 937621 www.edilkamin.it mail@edilkamin.it	Manufacturer: EDILKAMIN SPA Via Mascagni 7 20020 Lainate (MI) – ITALY						

(*) PM = particulate matter, OGCs = organic gaseous compounds, CO = carbon monoxide, NO_x = nitrogen oxides

(**) Only required if correction factors F(2) or F(3) are applied.

PREPARATION AND UNPACKING

The packaging materials are neither toxic nor noxious and do not require special disposal.

The end user is responsible for storing, disposing of and recycling them in a regulatory fashion.

The packaging may vary in the various destination countries for regulatory and transport-related reasons.



Always move the stove in an upright position with suitable equipment and in observance of safety regulations.

Do not turn the package over, and handle all parts requiring installation with care.

DEFLECTOR

The product is supplied with the deflector not installed: insert it as shown in the figure.

The deflector is a component subject to wear.

Neither Edilkamin nor the dealer shall be held liable should this component break, all the more if it breaks accidentally during handling operations.

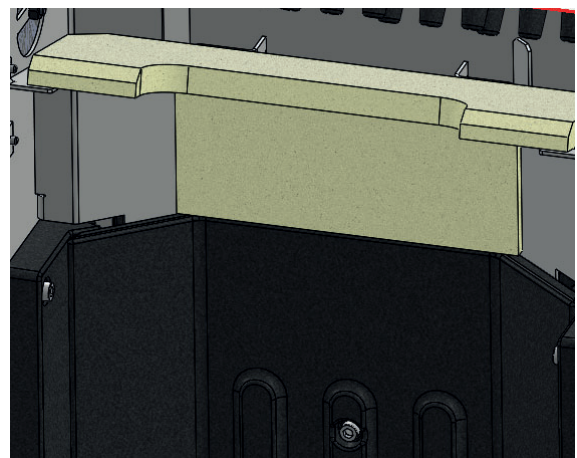

THE DRAWINGS ARE PURELY INDICATIVE AND ARE USEFUL FOR ASSEMBLY PURPOSES, BUT DO NOT ALWAYS REFER TO THE SPECIFIC MODEL.







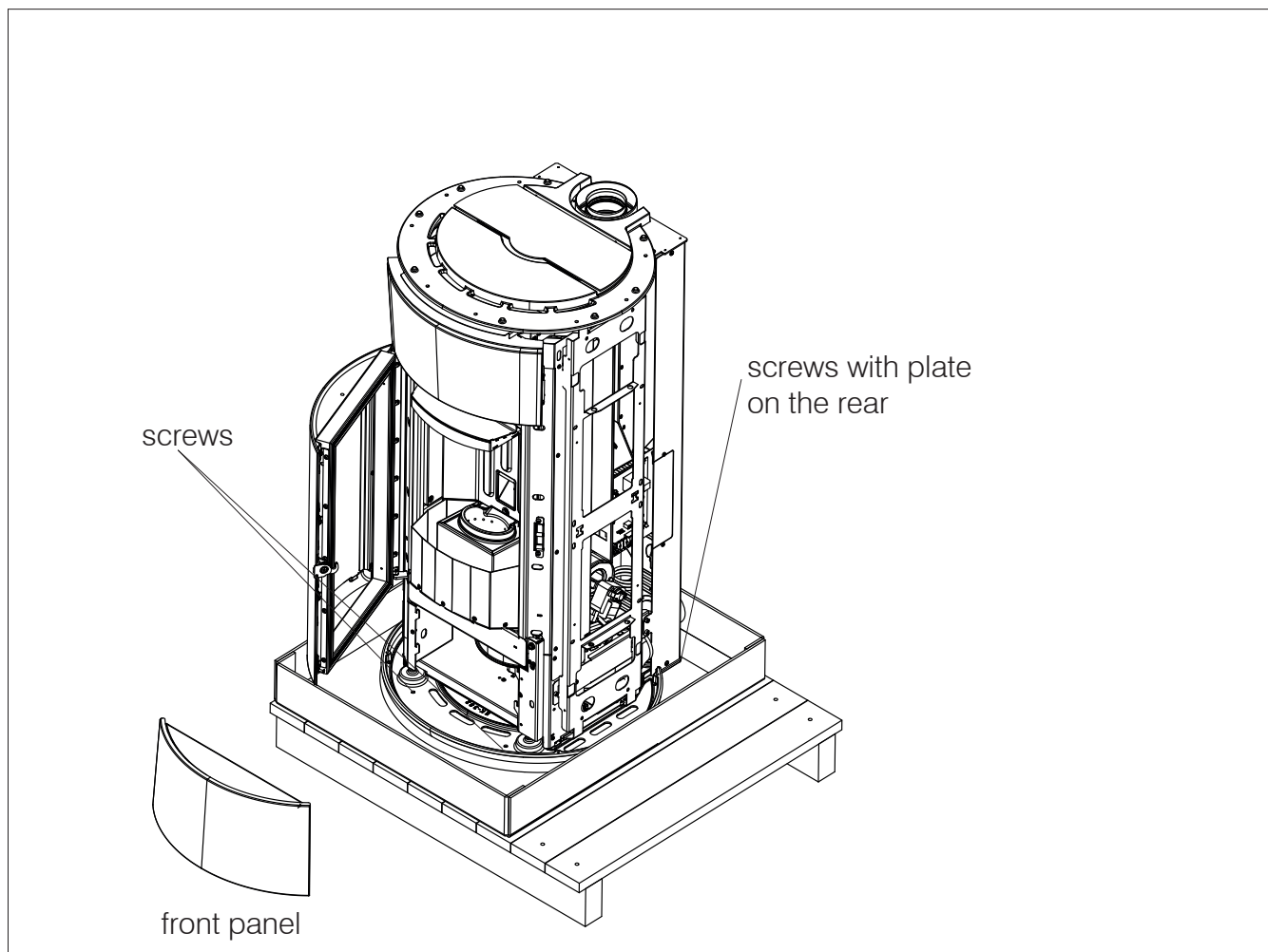

DO NOT ATTEMPT TO REMOVE THE PRODUCT FROM THE PALLET BEFORE HAVING:

- OPENED THE DOOR;
- REMOVED THE FRONT PANEL (lift it to detach it);
- LOOSENED THE SCREWS FASTENING IT TO THE PALLET.

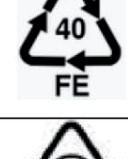

THE DRAWINGS ARE PURELY INDICATIVE AND ARE USEFUL FOR ASSEMBLY PURPOSES, BUT DO NOT ALWAYS REFER TO THE SPECIFIC MODEL.

DESCRIPTION	MATERIAL CODING	SYMBOL	INSTRUCTIONS FOR COLLECTION
- WOODEN PALLET - WOODEN CAGE - WOODEN PALLET	WOOD FOR 50		WOOD SEPARATE collection Check with your Municipality on how to deliver this packaging to the collection point
- CARDBOARD BOX - CARDBOARD CORNER - CARDBOARD SHEET	CORRUGATED CARDBOARD PAP20		PAPER SEPARATE collection Check the regulations of your Municipality
- APPLIANCE BAG - ACCESSORY BAG - BUBBLE WRAP - PROTECTION SHEET - LABELS	POLYETHYLENE LD PE 04		PLASTIC SEPARATE collection Check the regulations of your Municipality
- POLYSTYRENE - CHIPS	POLYSTYRENE PS 6		PLASTIC SEPARATE collection Check the regulations of your Municipality
- STRAP - ADHESIVE TAPE	POLYPROPYLENE PP5		PLASTIC SEPARATE collection Check the regulations of your Municipality
- SCREWS - STAPLES FOR STRAP	IRON FE 40		METAL SEPARATE collection Check with your Municipality on how to deliver this packaging to the collection point
- POLYETHYLENE BAGS CONTAINING POLYURETHANE FOAM	POLYURETHANE 07 HDPE 02 + PUR		MIXED waste Check with your Municipality on how to deliver this packaging to the collection point

Depending on how the packaging is received, assemble the side panels using the screws provided or mount the assembled side panels on the structure.

1. Remove the top

List the cover of the pellet to open it.

Loosen the screws indicated below.

Pull the top towards yourself to slot it out and lift it.

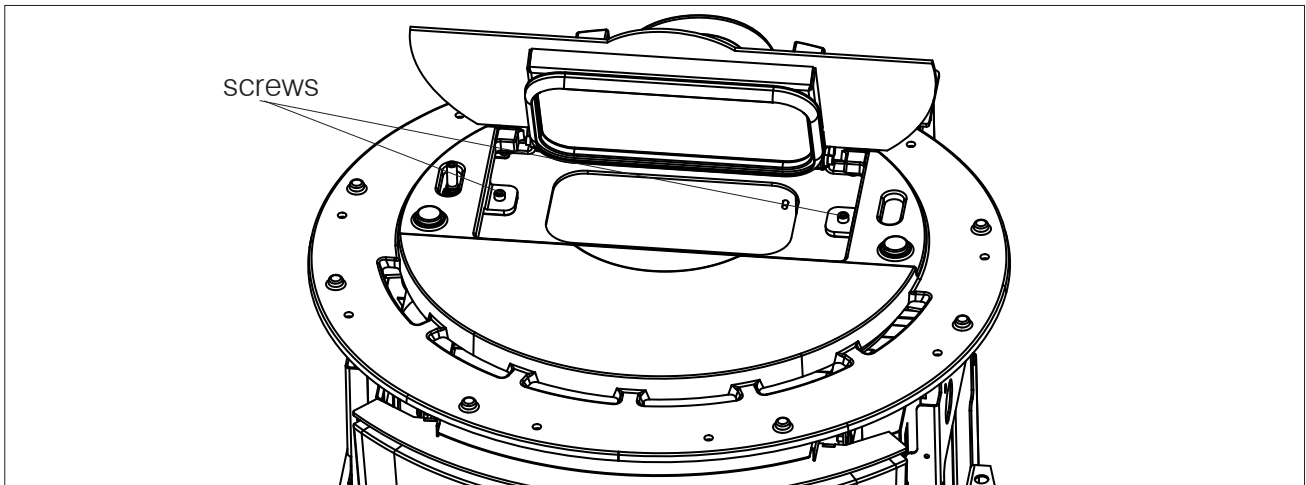

2. Assembling and fitting the side panels onto the structure

On each of the sides, undo the metal support screws, unhook the metal support and remove it.

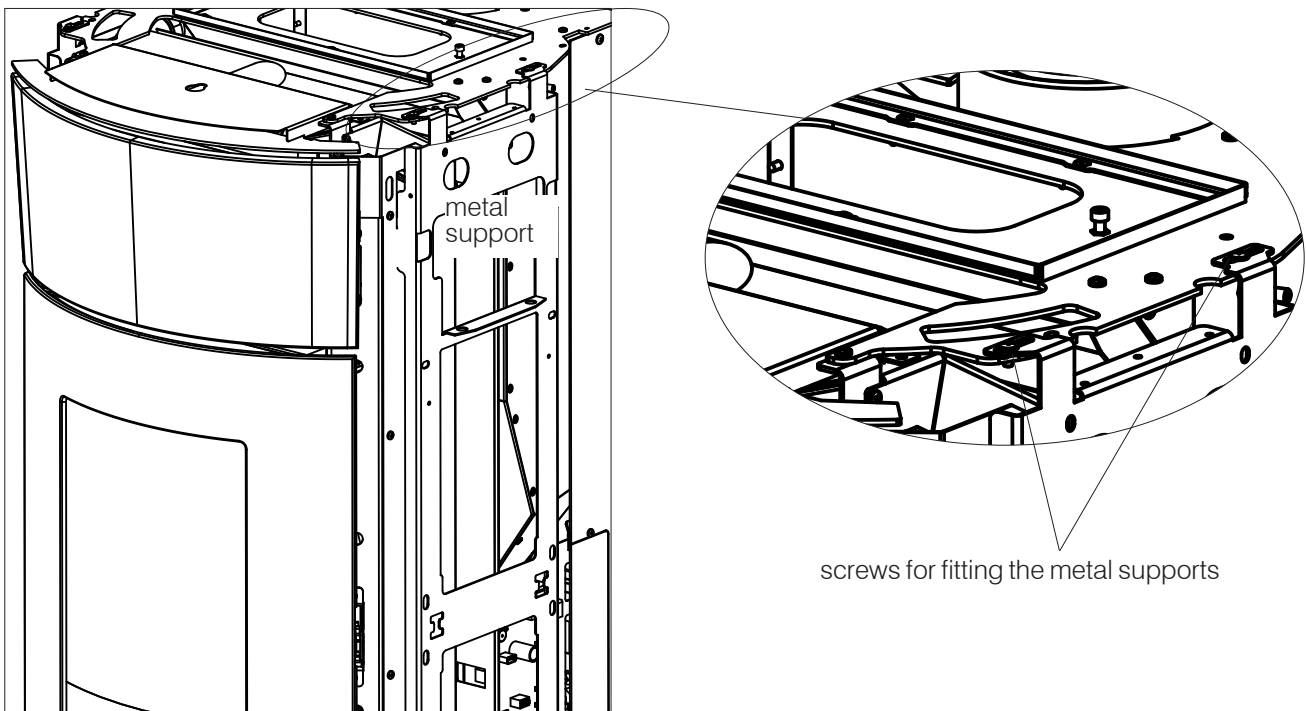

To assemble the two sides, we recommend that you place them on the shaped polystyrene piece and proceed as follows.

1. bring the side panels (1) together, place the central spacer and screw them together;

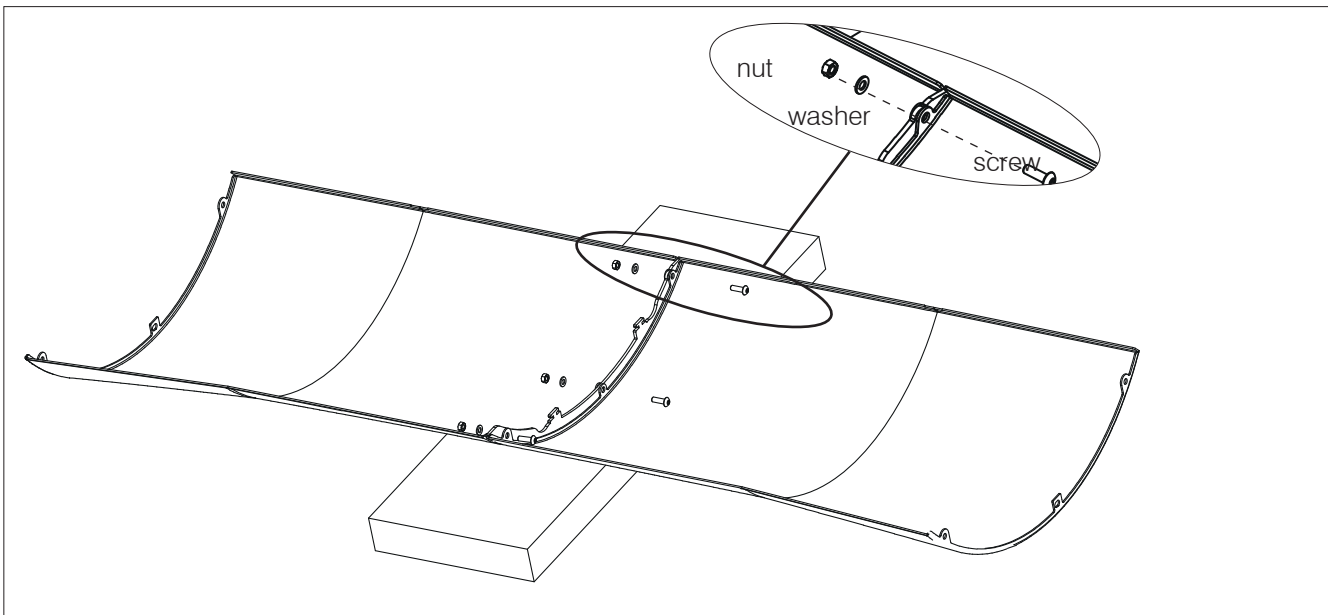
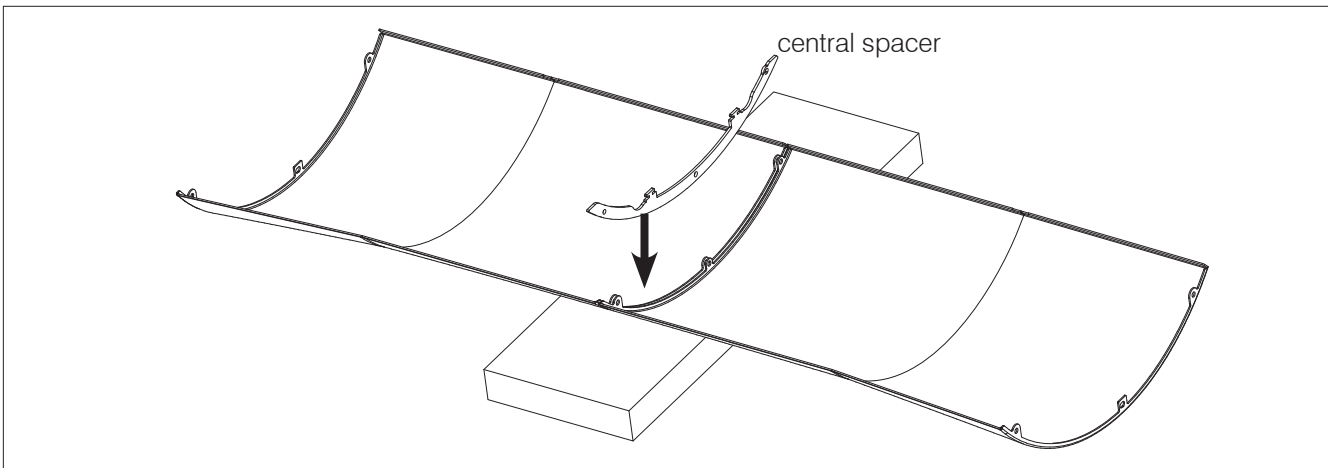
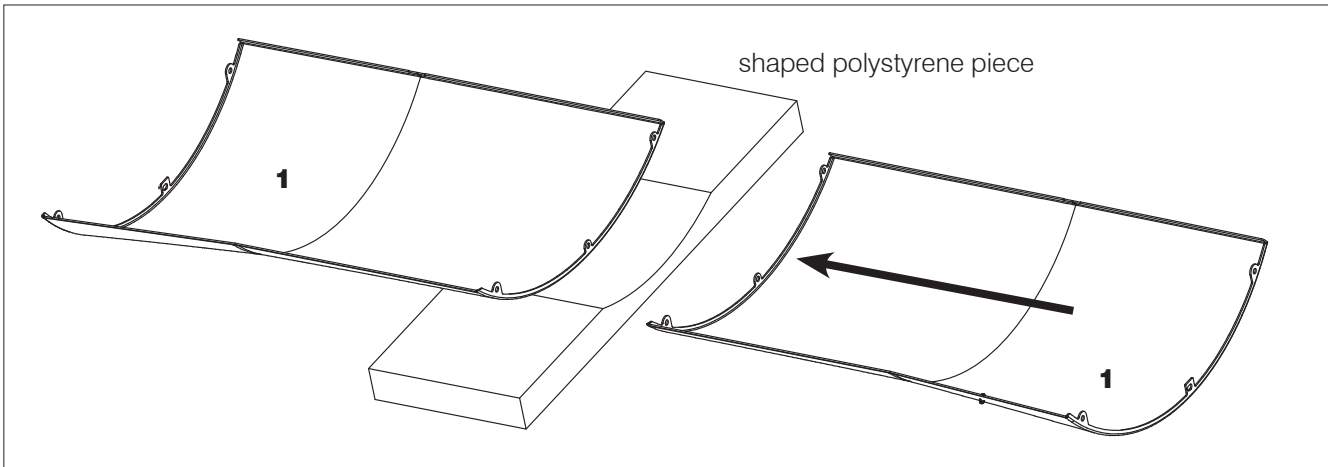

NOTE. The curving of the side panels may not perfectly coincide with the curving of the brackets. Therefore, use your hands to make the panel fit to the bracket before tightening the screws. Do not use any tools so as to avoid the risk of scratching the side panel. Once the position of the side panel is correct, tighten the screws while keeping the side panel in position. This will also avoid any interference with the door.

2. Place the brackets. Tighten the screws and also insert the nuts and washers above and underneath, only on one side.

NOTE. For a better understanding of the position, the image below shows the components in a vertical position, but we nevertheless recommend that you work in a horizontal position on top of the shaped polystyrene piece.

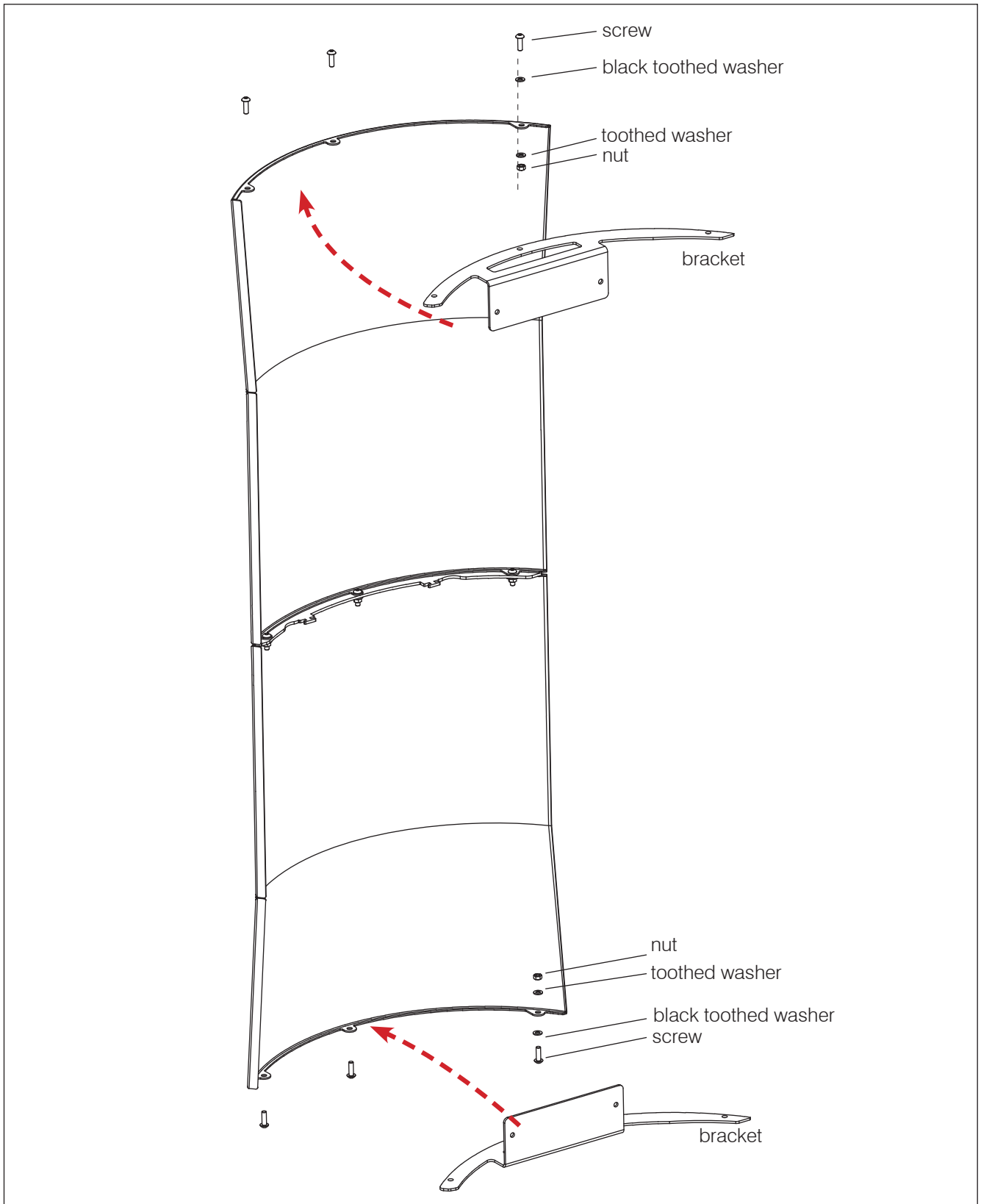

3. position the metal support. Tighten the screws and also insert the nuts and washers above and underneath, only on one side.

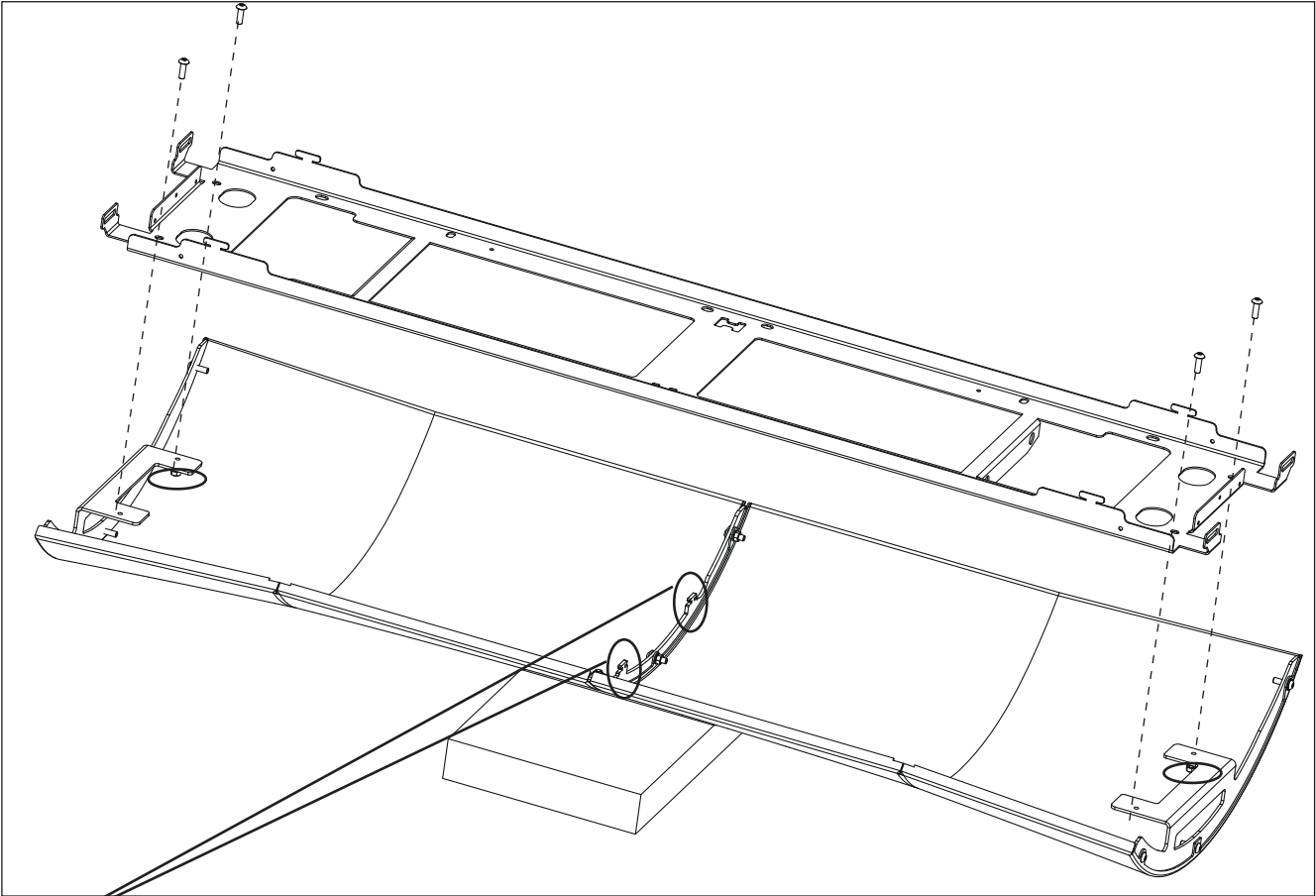

ENGLISH

18

Make sure that the central spacer has been placed in the "cut" on the metal support.



"cut" on the metal support

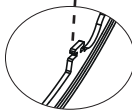

central spacer

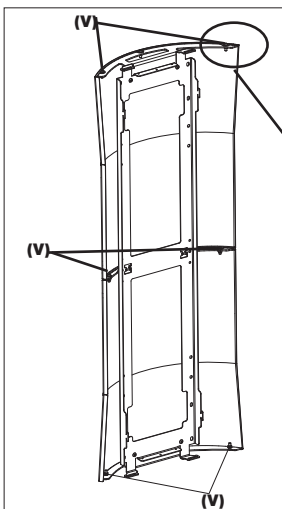

NOTE. The curving of the side panels may not perfectly coincide with the curving of the brackets. Therefore, use your hands to make the panel fit to the bracket before tightening the screws **(V)**. Do not use any tools so as to avoid the risk of scratching the side panel. Once the position of the side panel is correct, tighten the screws while keeping the side panel in position. This will also avoid any interference with the door.

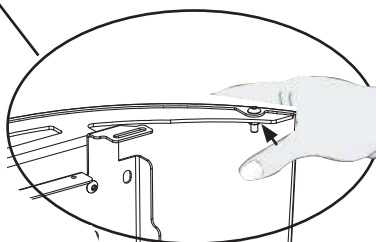

Then hook the assembled side panel with the metal support to the structure (inside the slots) and re-tighten the screws securing the metal supports.

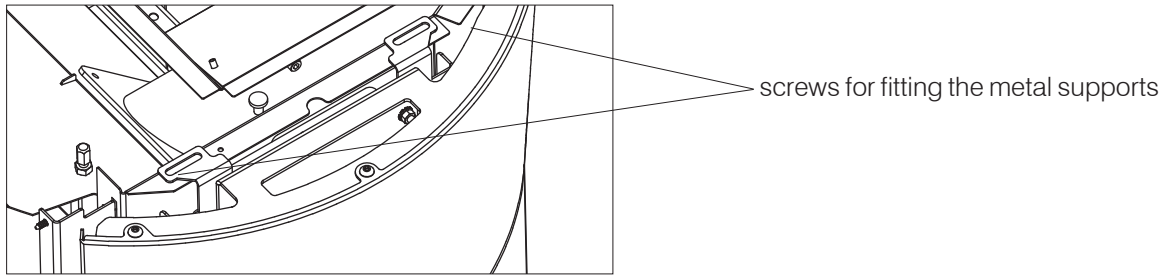

3. Assembling and mounting the top

Place the cast iron inserts on the upper part of the top and screw them on from below, as shown in the figure. Insert the top and screw it to the structure as explained in point 1.

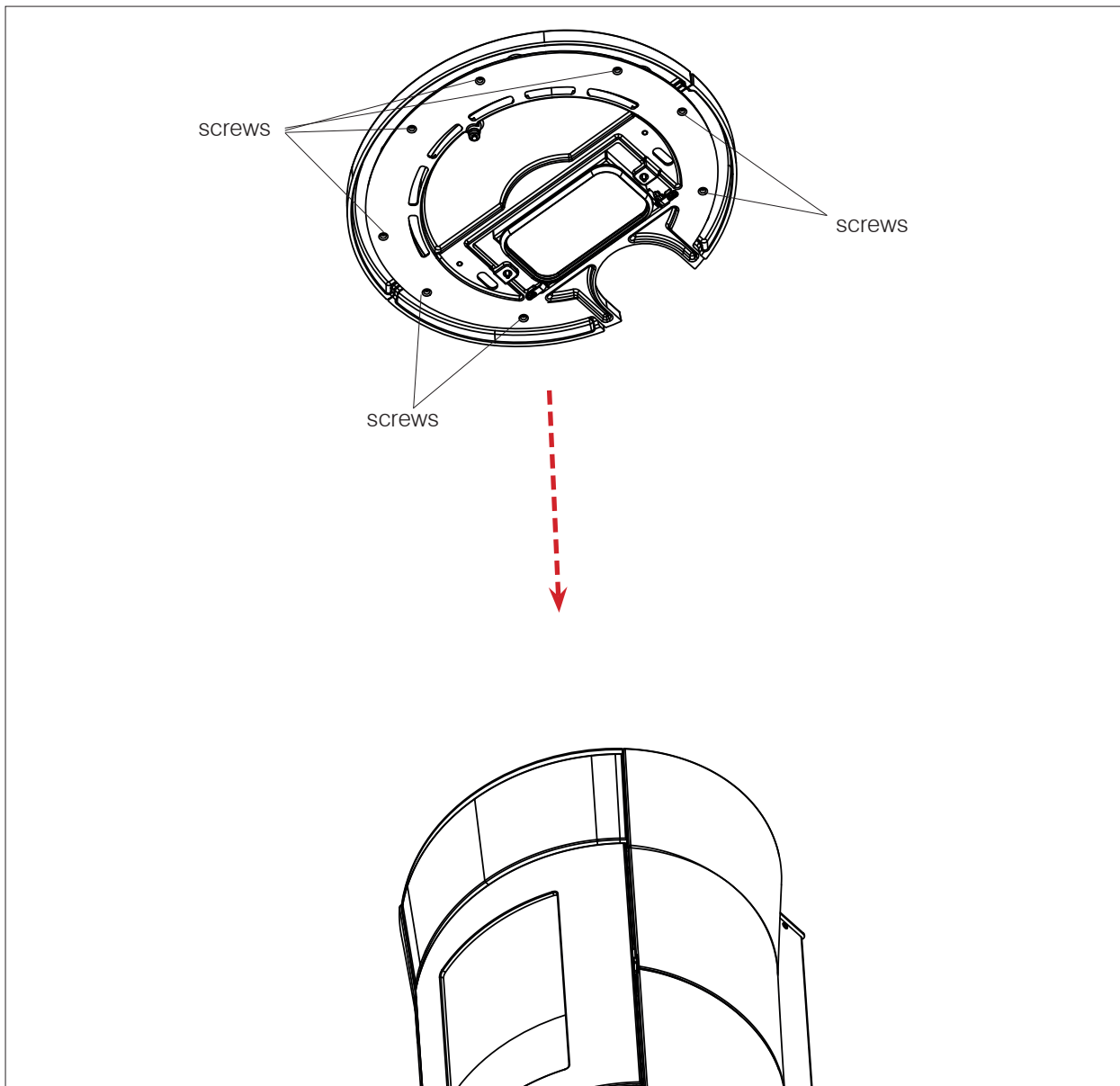

Depending on how the packaging is received, assemble the side panels using the screws provided or mount the assembled side panels on the structure.

1. Remove the top

List the cover of the pellet to open it.

Loosen the screws indicated below.

Pull the top towards yourself to slot it out and lift it.

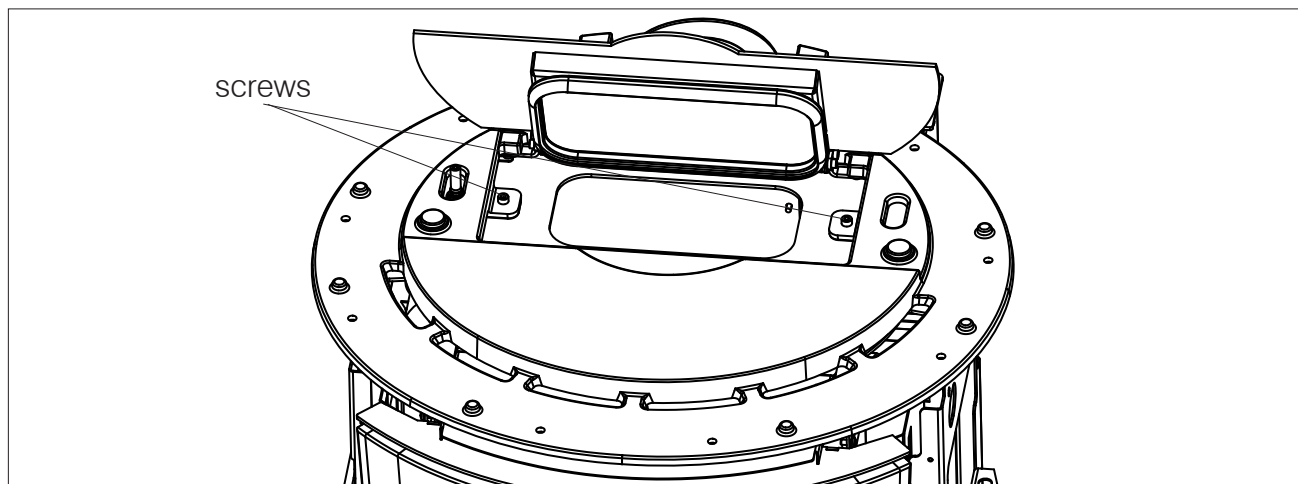

2. Assembling and fitting the side panels onto the structure

On each of the sides, undo the metal support screws, unhook the metal support and remove it.

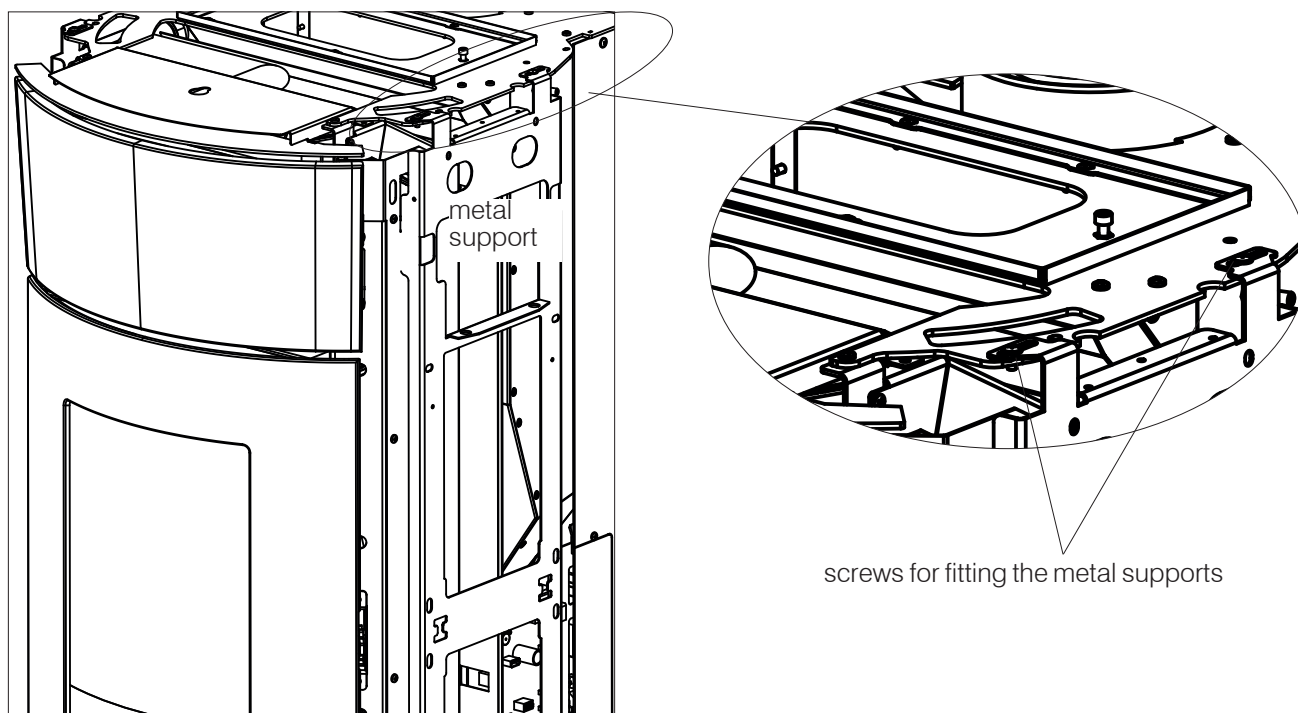

To assemble the two sides, we recommend that you place them on the shaped polystyrene piece and proceed as follows.

Bring the ceramic side panels together (1).

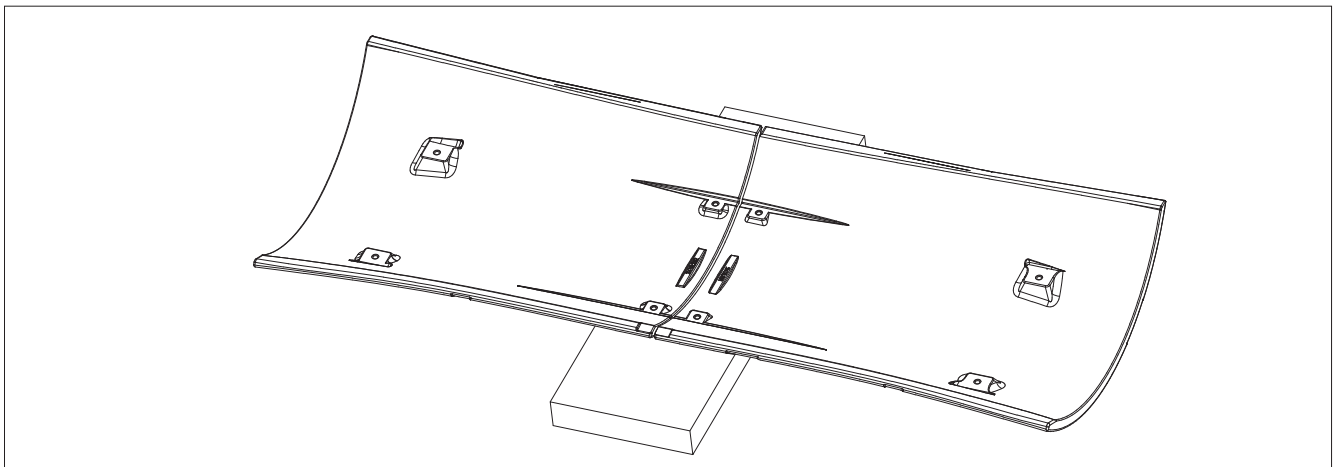
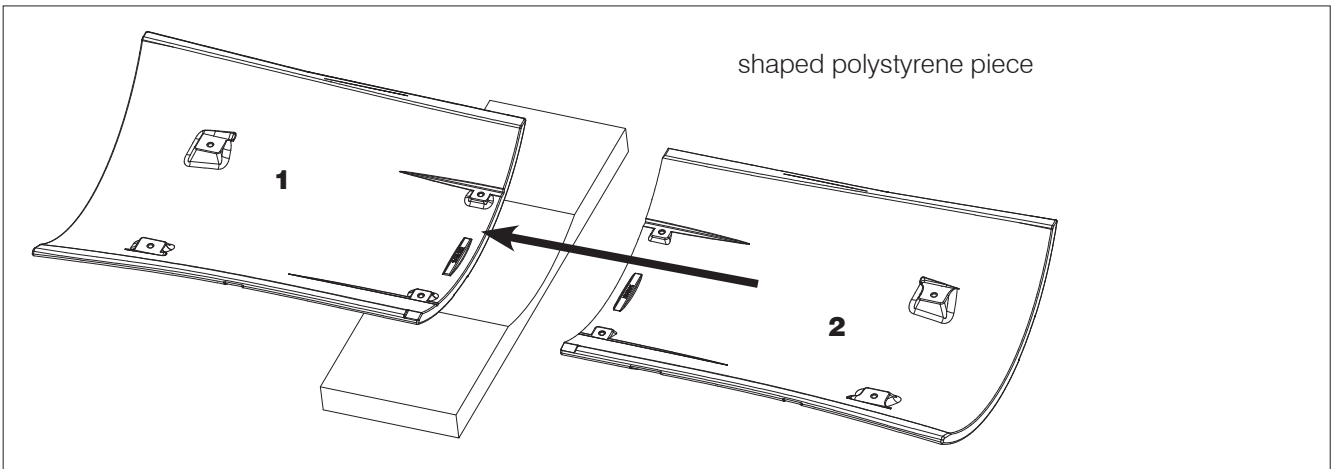

Position the two adjustment brackets on the ceramic piece and apply the screws without tightening them.

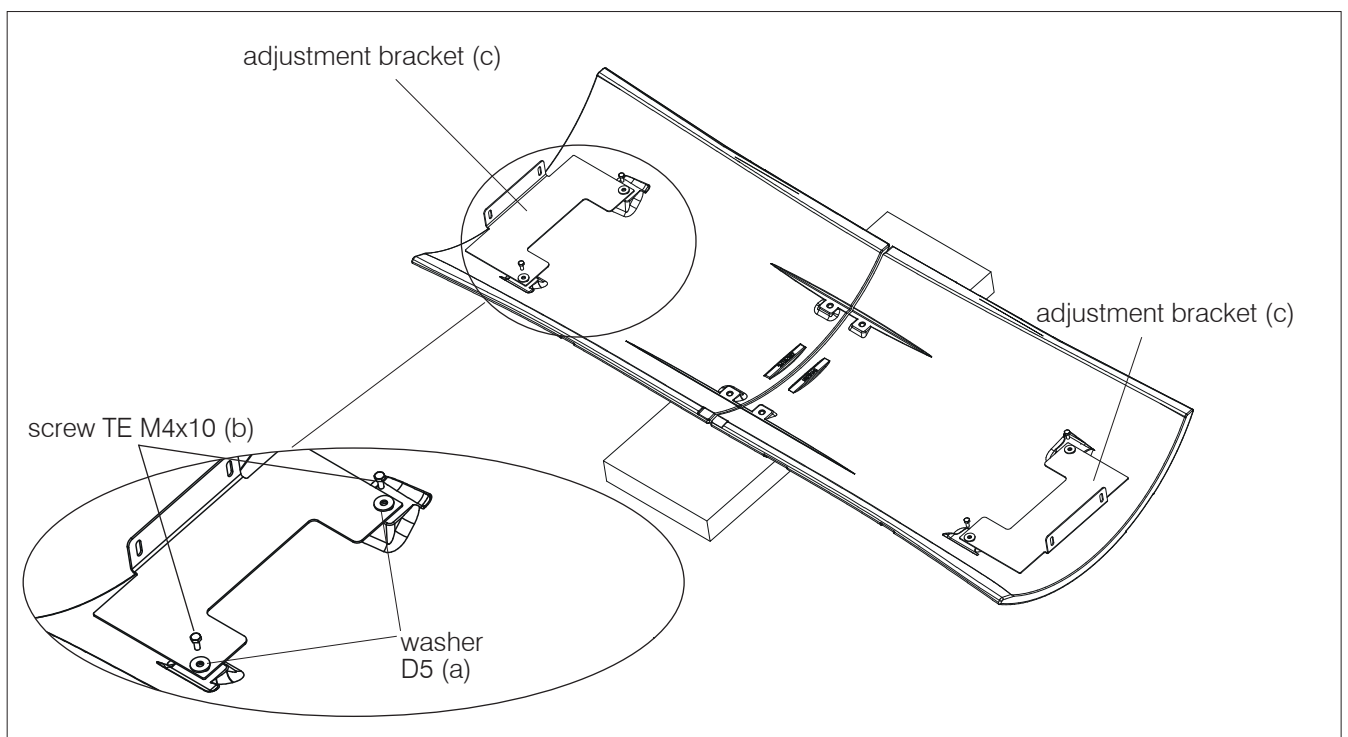

Position the small bracket with the cage nut on the metal support and screw on with the supplied M4.2x9.5 screw. The drawing shows the left side panel (for the location of the small adjustment bracket).

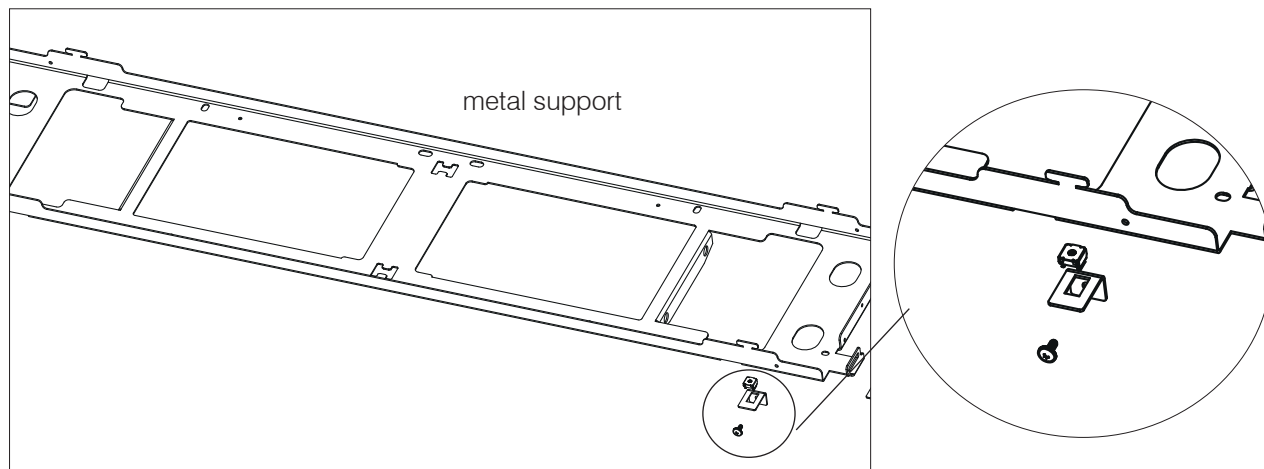

Once the metal support has been assembled with the small bracket, place it on the ceramic pieces and apply the screws and washers but without tightening, as shown in the figure below.

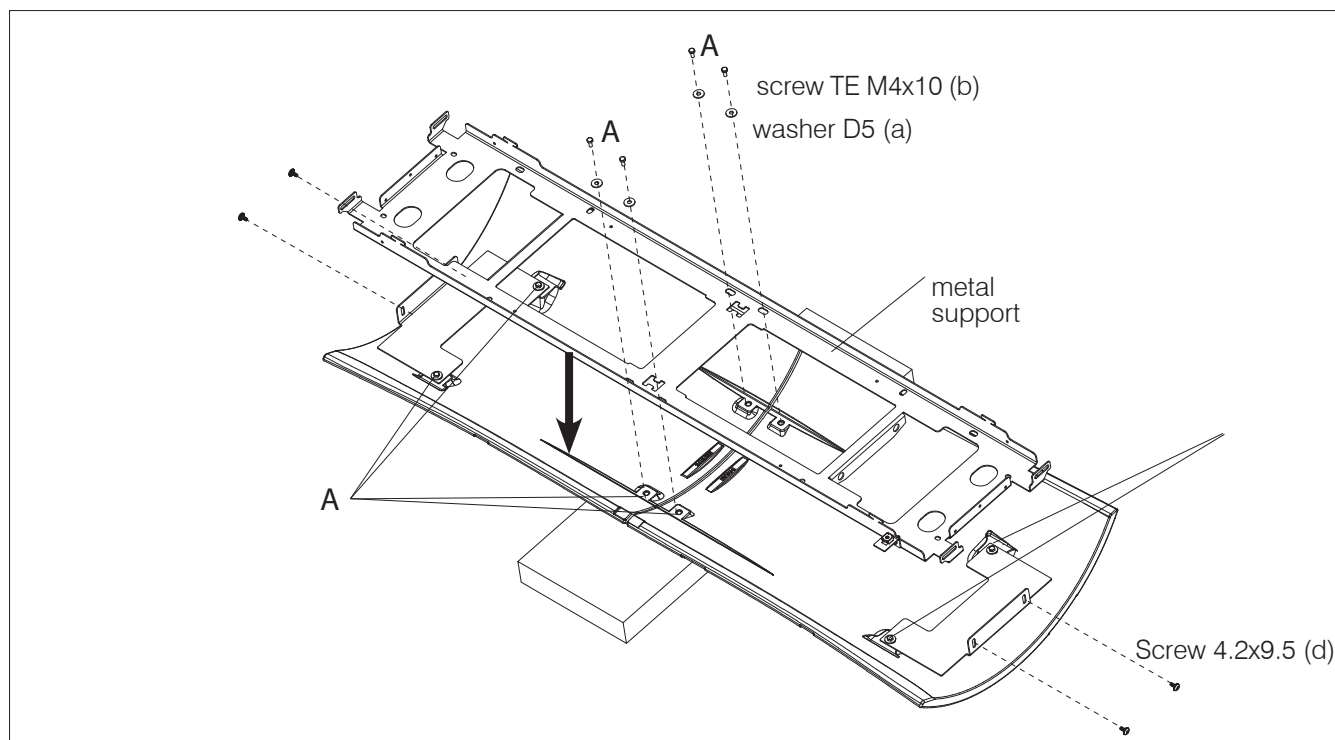

Do not force the screw into the threaded bushing to avoid breakage. Apply silicone at high temperature in the holes (A) to favour the component stability.

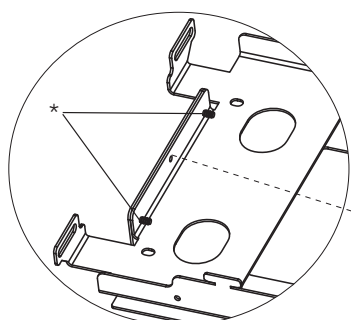

The correct position is the point where the bracket profile meets with the metal support. Tighten the screws that fix the brackets to the metal profile *

Before tightening the screws, for each of the two ceramic pieces (above and below):
position the template for fitting the side panels;

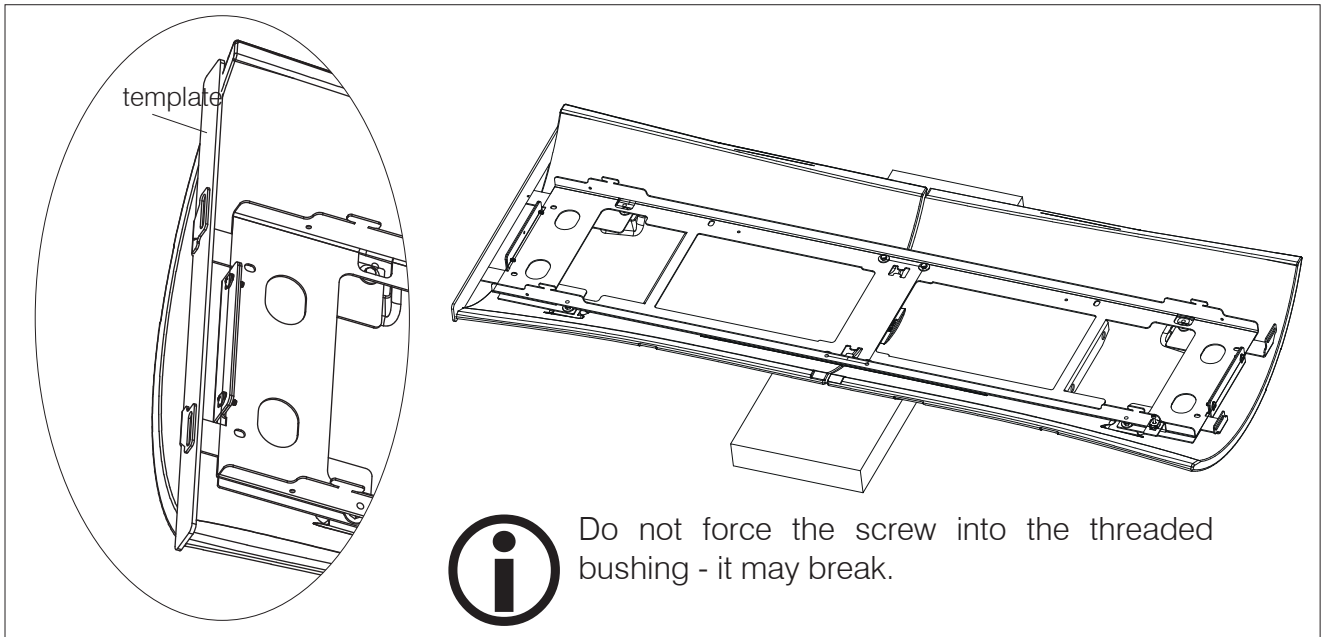

Respect the distances between the metal support and the ceramic piece as in the drawing (60 and 70 mm). The 70 mm measurement can also be taken from the template position.

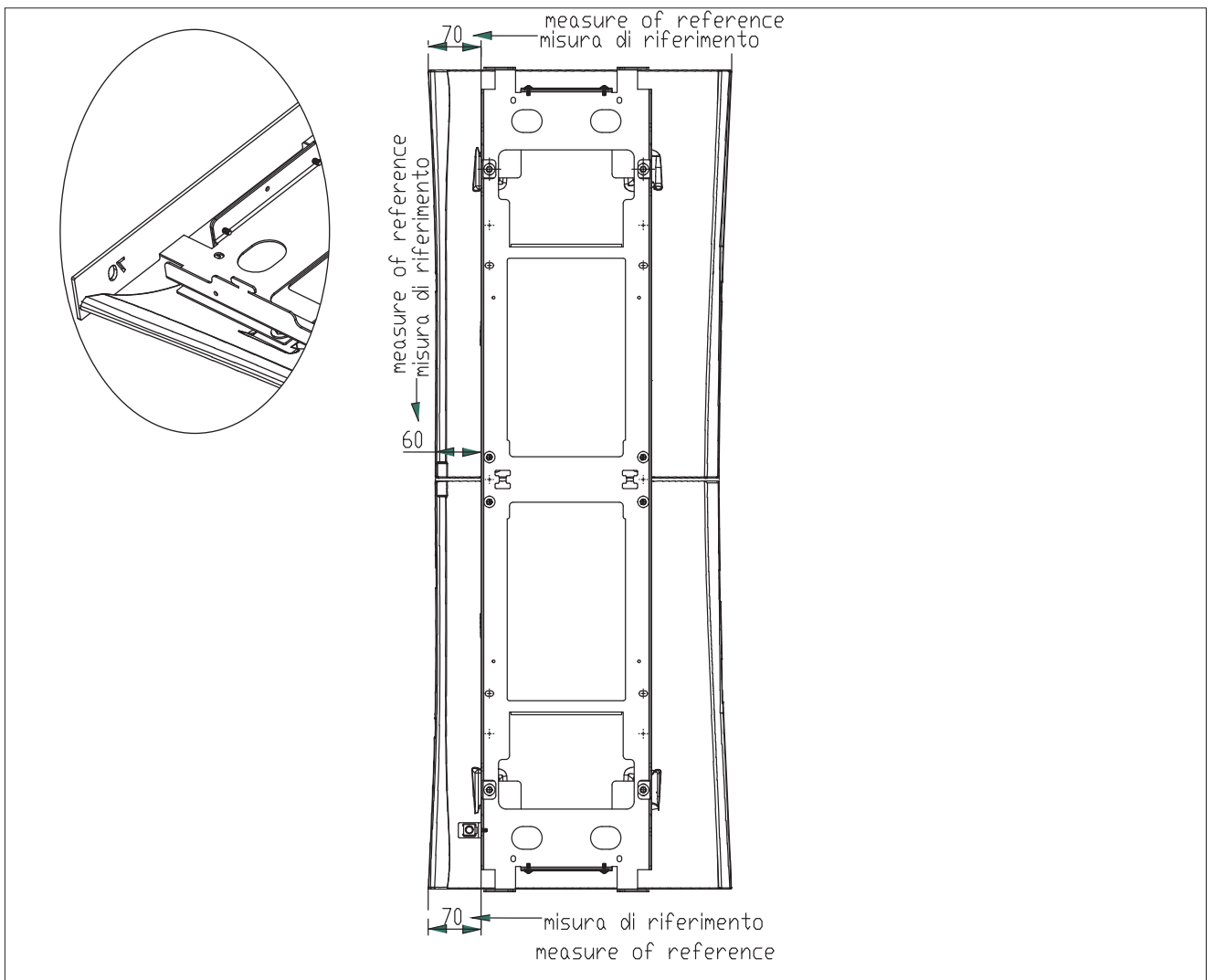

Then hook the assembled side panel with the metal support to the structure (inside the slots) and re-tighten the screws securing the metal supports.

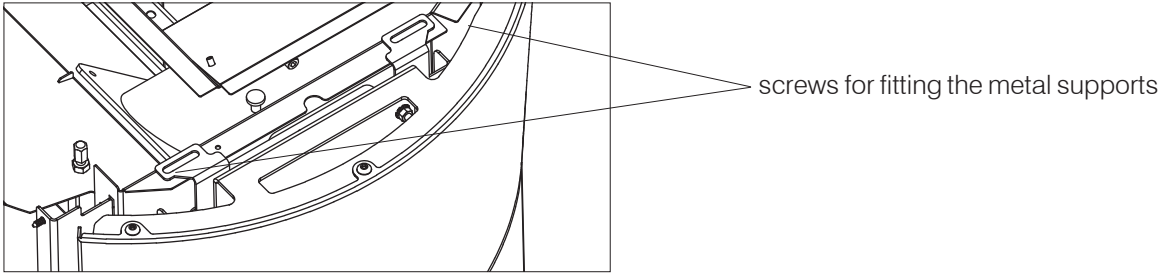

POSSIBLE ADJUSTMENTS

The brackets allow internal/external adjustment.

The slots allow forward/backward adjustment in the top part.

The small brackets allow forward/backward adjustment in the bottom part.

The adjustment screw on the small bracket is used to secure the side panel and to further adjust its position.

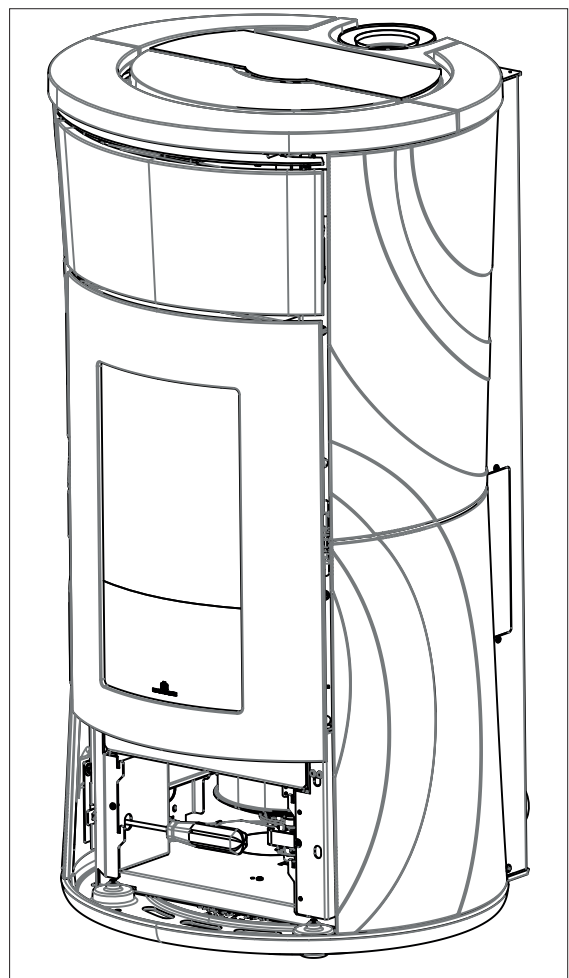
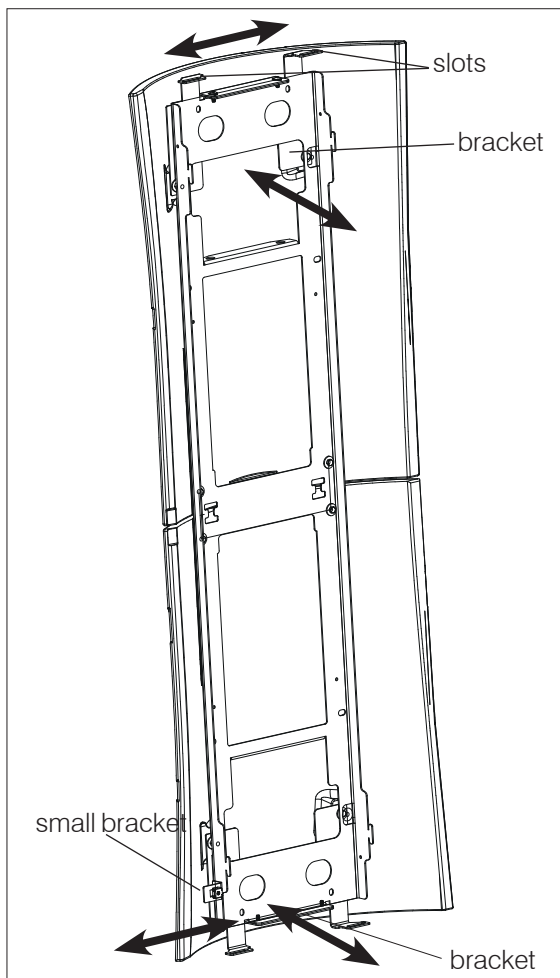

3. Assembling and mounting the top

Place the cast iron inserts on the upper part of the top and screw them on from below, as shown in the figure. Insert the top and screw it to the structure.

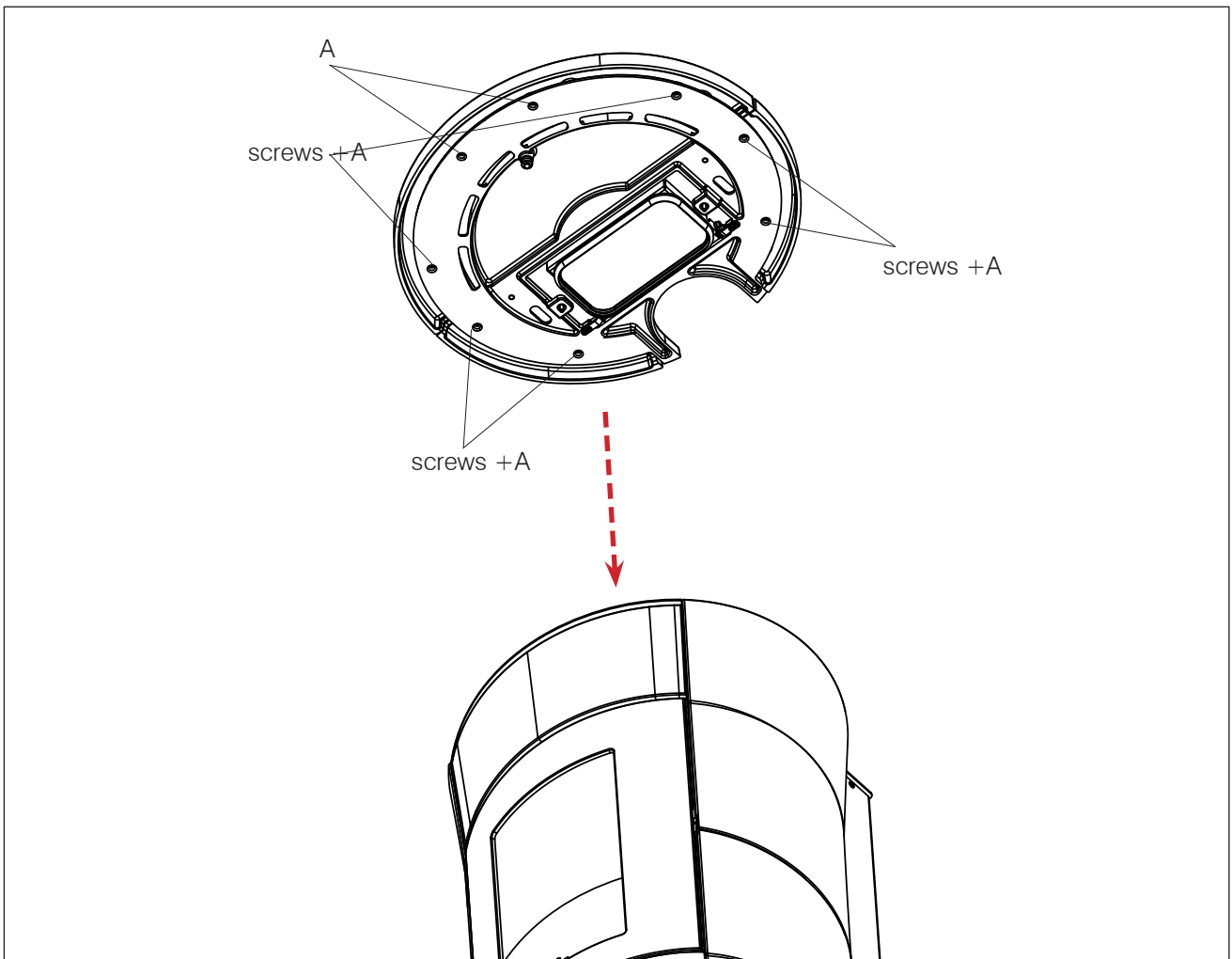

Do not force the screw into the threaded bushing to avoid breakage.
Apply silicone at high temperature in the holes (A) to favour the component stability.

1. Remove the top

List the cover of the pellet to open it.

Loosen the screws indicated below.

Pull the top towards yourself to slot it out and lift it.

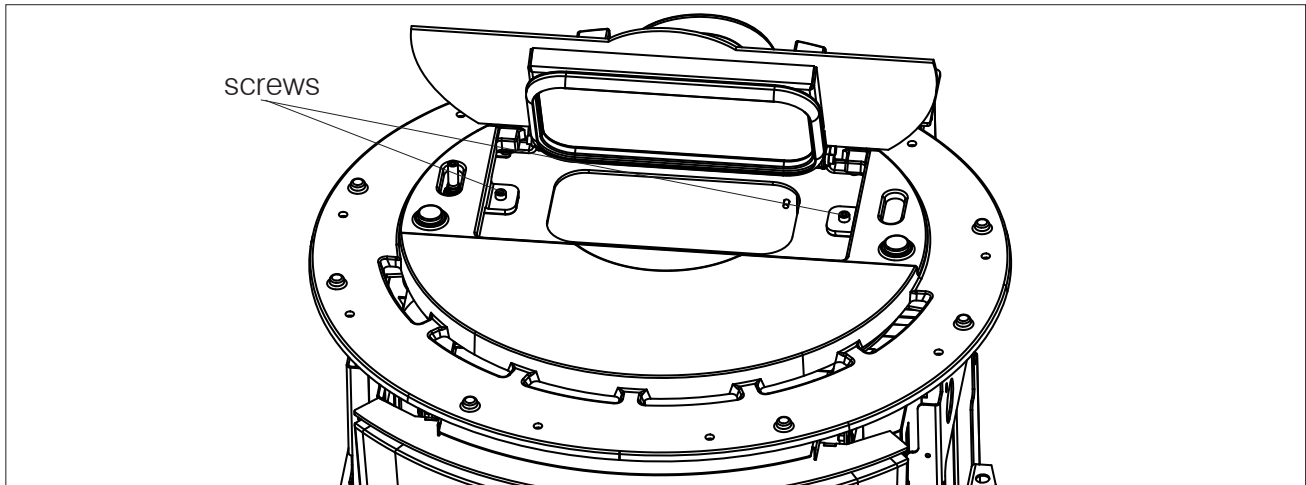

2. Assembling and fitting the side panels onto the structure

On each of the sides, undo the metal support screws, unhook the metal support and remove it. The support will not be used.

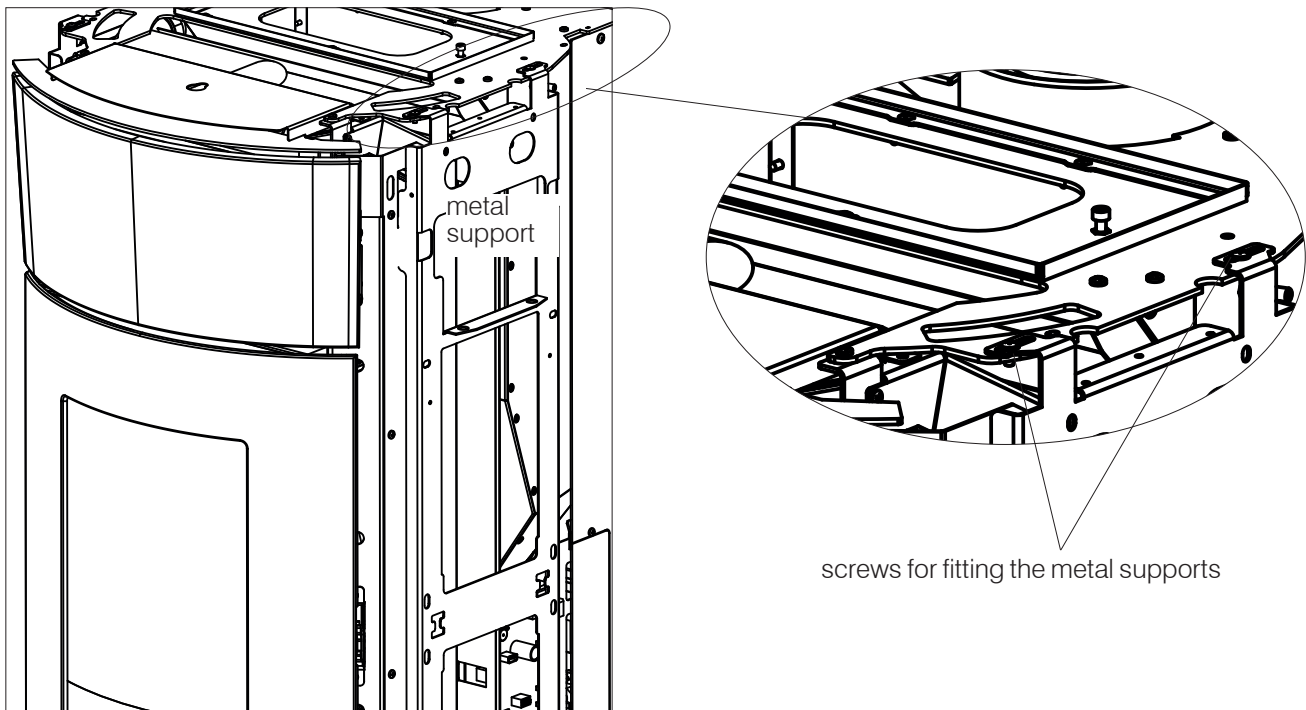

Then hook the assembled side panel with the metal support to the structure (inside the slots) and re-tighten the screws securing the metal supports.

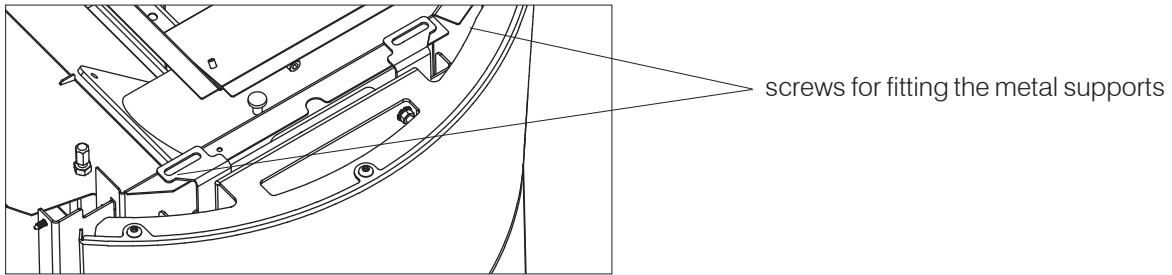

3. Assembling and mounting the top

Place the cast iron inserts on the upper part of the top and screw them on from below, as shown in the figure. Insert the top and screw it to the structure as explained in point 1.

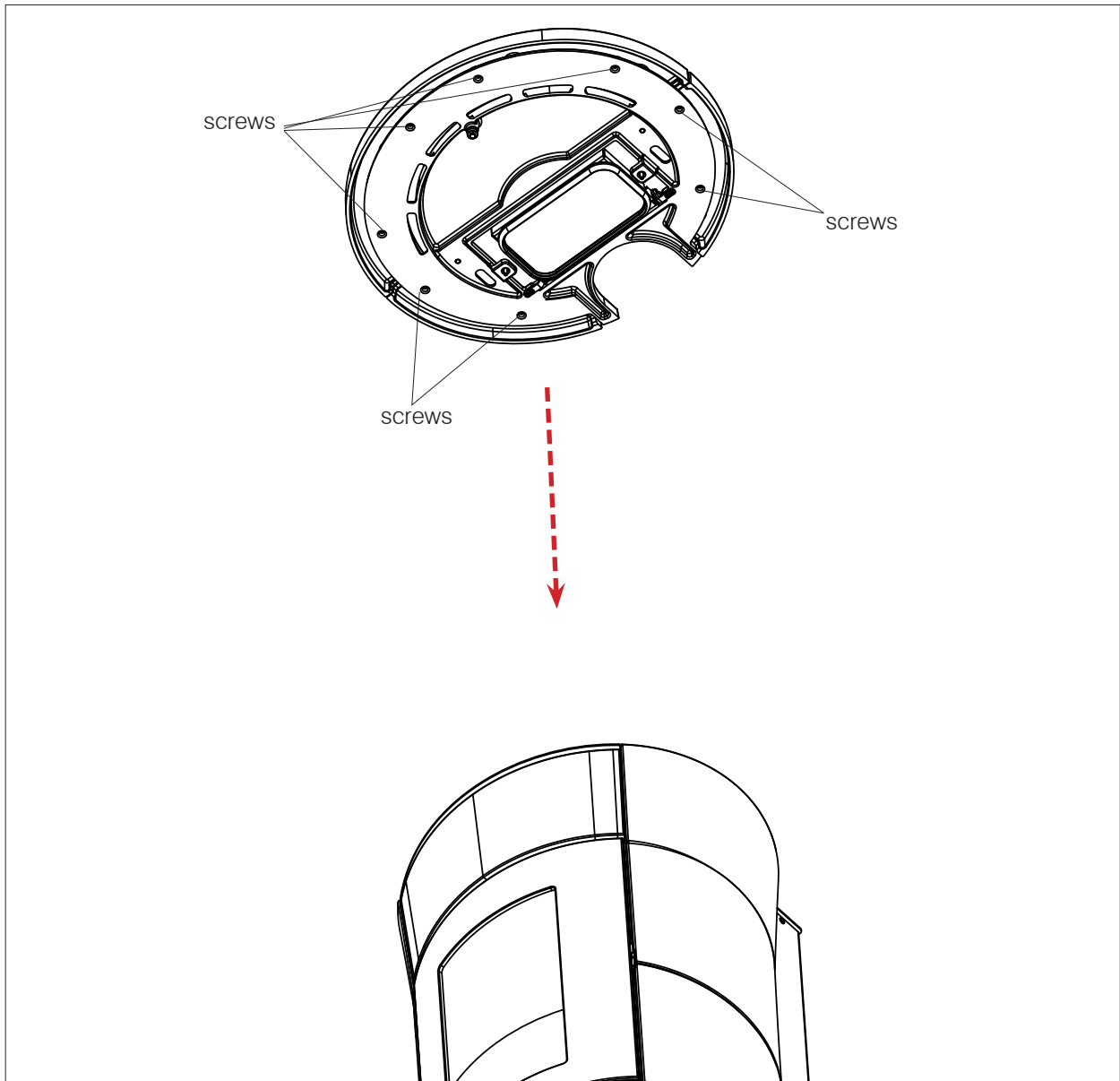

REMARKS ON INSTALLATION

Please note that:

- the installation must be carried out by qualified personnel;
- the appliance must be installed and used in compliance with all local and national law and with European regulations; The Italian reference standard is UNI 10683; in France it is necessary to observe the instructions of the DTA (Document Technique d'Application Référence Avis Technique), www.cstb.fr;
- if the product is installed in a condominium, the appliance must be approved by the administrator;
- if the product is installed in public premises, check and follow the local regulations applicable to this type of installation.

Below are a few general instructions which, however, do not obviate the need to comply with local regulations and do not imply any liability on the installer's job. Bear in mind that the stove is sealed, in other words, if it is installed correctly with the air inlet pipe connected to the outside, it takes in most of the air from the outside. In every country check whether there are any particular installation conditions allowed for sealed stoves.

Checking the suitability of the room of installation

- The room must have a volume of at least 30 m³.
- The floor must be able to bear the weight of the product and its accessories* (see the note in the paragraph on heat protection).
- Level the appliance.
- Do not install the product in rooms where there is a risk of fire or explosion.
- In Italy, verify the compatibility pursuant to the UNI 10683 and UNI 7129 standards in the presence of gas-fired products.

Protection from heat and safety clearances

The surfaces of the building adjacent to the product must be protected against overheating.

The insulation to be used will depend on the type of surface in question.

The appliance must be installed in accordance with the following safety instructions:

- minimum clearance of 15 cm at the sides and 10 cm at the back from flammable materials;
- no flammable materials may be kept closer than 80 cm from the front of the appliance.

If the product is installed with a wooden wall or a wall made of other flammable material, the flue must be appropriately insulated.

If the product is installed on a flammable and/or combustible floor, or on a floor incapable of bearing its load*, we recommend placing a steel or glass plate under the stove to distribute the load.

Contact the retailer for this type of optional feature.

Positioning the product

The product is designed to operate in all climate conditions. In special circumstances, such as strong wind, the safety devices may intervene to switch the appliance off.

Contact the authorised Edilkamin Technical Assistance Centre.



NOTE

The smoke outlet diameter does not match the chimney system diameter. The chimney system must be sized in accordance with the national and local regulations.

In particular (this is not an exhaustive list), refer to the EN 13384, EN 1443, EN 1856, EN 1457 standards and to all local regulations.

FLUE SYSTEM

(Fumes duct, flue and chimney pot)

This chapter has been drawn up pursuant to European regulations EN 13384, EN 1443, EN 1856 and EN 1457. The installer must observe both these and any other local regulations. This manual does not in any way substitute the applicable regulations.

The product must be connected to a smoke exhaust system which ensures that the smoke produced by combustion is expelled in complete safety.

Before positioning the appliance, the installer must check that the flue is suitable.

SMOKE DUCT, FLUE

The smoke duct (which connects the combustion chamber smoke outlet with the flue inlet) and the flue itself must, among other regulatory requirements, generally:

- receive the outlet from a single product only (outlets of more than one product together are not allowed)*; specific regulations apply in certain countries, therefore the installer must ensure that the local regulations have been observed;
- be installed vertically for the most part;
- have no downward sloping sections;
- preferably have a round internal cross-section and nevertheless with a ratio between the sides below 1.5;
- end at roof level with a proper chimney pot: the flue may not discharge directly on the wall or into an enclosed space, even if the space in question opens onto the sky;
- be made of material rated fire reaction class A1 per UNI EN 13501 or analogous national regulations;
- be appropriately certified, with a suitable chimney plate if made of metal;
- maintain the same cross-section throughout: it may only vary immediately after the outlet, not along the flue.

THE SMOKE DUCT

In addition to the general requirements for the fume duct and the flue, the fume duct:

- may not be made of flexible metal material;
- must be insulated if routed through unheated areas or outside;
- must not be routed through rooms where the installation of combustion heat generators is prohibited, or that are subject to potential fire, or that cannot be inspected;
- must enable the recovery of soot and be open for inspection;
- generally speaking, must not have more than 3 bends with a 90° maximum angle; the technician who sizes them must assess the situation;
- generally speaking, if there is a horizontal section, it can have a maximum/average length of 3 metres, depending on the draught. Nonetheless, take into account that long sections favour dirt build-up and are harder to keep clean; the technician who sizes the pipes must assess the situation.



Avoid infiltration of condensate water through the flue. If necessary, mount an anti-condensate ring – ask your chimney sweeper for details.

Damage caused by condensate water is not covered by the warranty.



* In some nations, installations with multiple flues are permitted under certain conditions. Depending on regional regulations, additional safety systems are necessary in case of connection to multiple flues. Your chimney sweeper/technician will be able to provide further details.

THE FLUE:

In addition to the general instructions applicable to the fume duct and the flue, the flue:

- must only be used for discharging fumes;
- must be correctly sized to satisfy the requirements for flue gas discharging (EN 13384-1, a non-exhaustive example);
- must preferably be insulated, made of steel and with a round inner cross-section. If rectangular, the corners must have a radius of no less than 20 mm, with a ratio between the inner dimensions <1.5;
- must normally have a minimum height of 1.5 metres;
- must have a constant cross-section;
- must be waterproof and thermally insulated to ensure proper draught;
- preferably mount a collection chamber for unburnt residues and any condensate build-up;
- if pre-existing, it must be clean to prevent fire hazards;
- in general, we recommend embedding the flue in the existing masonry chimney if its diameter exceeds 150 mm; the technician who sizes the pipes must assess the situation.

EMBEDDED SYSTEM:

In addition to the general requirements applicable to the fume duct and the flue, the embedded system must:

- operate in negative pressure;
- be open to inspection;
- comply with the local regulations.

THE CHIMNEY POT

- must be anti-downdraught;
- must have an internal cross section equivalent to that of the flue and a fumes outlet at least double that of the interior of the flue;
- for dual flues (which should be spaced at least 2 m apart) the chimney pot receiving the fumes from the solid fuel appliance or that from the higher storey, must be at least 50 cm higher than the other;
- must extend beyond the back-flow zone (in Italy, refer to UNI 10683 point 6.5.8.);
- must allow for maintenance of the chimney.

EXTERNAL AIR INTAKE

In general, we suggest two alternative ways for ensuring a proper flow of indispensable combustion air.

Indirect air intake

Install an air outlet at floor level with an effective surface area (net of the screen or other protections) of at least 80 cm² (10 cm in diameter).

To prevent draughts, we recommend installing the intake behind the stove or behind a radiator.

Installing it in front of the appliance will create unpleasant draughts.

Direct air intake

Install an air intake with an effective size (net of the mesh or other protective equipment) that is at least equal to that of the air intake at the back of the product. Choose the diameter based on the load losses.

Connect the air intake to the appliance's air intake with a pipe that may also be flexible. Increase the pipe diameter if the pipe is not smooth: assess any load loss.

A maximum length of 5 metres is recommended, with no more than 3 bends depending on the draught of the flue.

The air may be drawn from an adjacent room only if:

- the flow is taken from permanent and unobstructed openings communicating with the outdoors;
- the air pressure in the adjacent room is never lower than that of the outdoor pressure;
- the adjacent room is not a garage, subject to fire hazard, a bathroom or a bedroom;
- the adjacent room is not a shared room in the building.

In Italy, the UNI 10683 standard states that ventilation is sufficient even if a pressure difference between the outdoors and indoors of no more than 4 Pa is guaranteed (UNI EN 13384-1 standard, a non-exhaustive example). The installer who issues the declaration of conformity is responsible for ensuring these conditions.

**USE OF CONCENTRIC PIPES
(CHERIE 9 EVO ATC/CHERIE 11 EVO ATC)**

Without prejudice to the general instructions, you can use concentric pipes (which provide for the passage of smoke inside and the passage of the combustion air into the external circular ring).

This type of installation only needs one hole in the wall, instead of having one hole for the air intake and one for the smoke discharge.

Examples of possible installations. For the smoke discharge conditions (on roof, etc.) check local regulations for sealed pellet stoves.

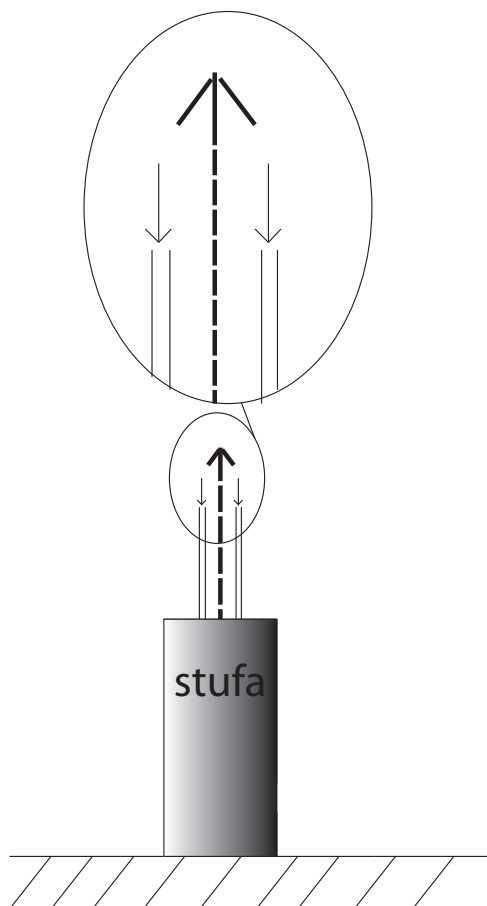

Upper coaxial fumes discharge and air intake

DUCTING OF heating air:

- **CHERIE 9 EVO ATC/CHERIE 9 EVO AT** is compatible with 1 ducting system on the rear.
- **CHERIE 11 EVO ATC/CHERIE 11 EVO AT** is compatible with 2 ducting systems on the rear.



The length of the ducting system and the temperature of the air leaving the air vent depend on the usage and installation conditions.

We suggest properly sizing the ducting system.

We recommend using only smooth pipes internally.

If the system is not ducted, to maximise the power output we recommend purchasing the air diverter kit (A) appearing in the price list.

(A)



To duct the warm air exiting the rear, there are several optional accessories available at your dealer.

The adjustment process is described in the "Instructions for use" paragraph.

INITIAL START-UP PHASES

- Make sure you have read and understood this manual.
- Remove all flammable materials from the appliance (manuals, labels, etc.). In particular remove any labels from the glass.
- Make sure the technician has carried out the initial start-up of the product and has also filled the pellet reservoir for the first time.

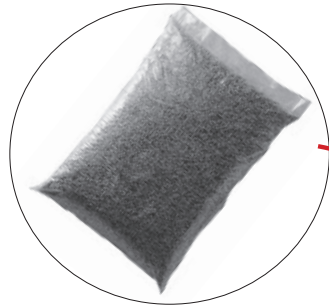

LOADING PELLETS INTO THE TANK

To load the pellets:
Open the pellet loading door and pour the pellets inside.
Be careful not to let any pellets spill.

* Check that you have closed the tank. A switch will stop the pellets from falling in if it has been left open.

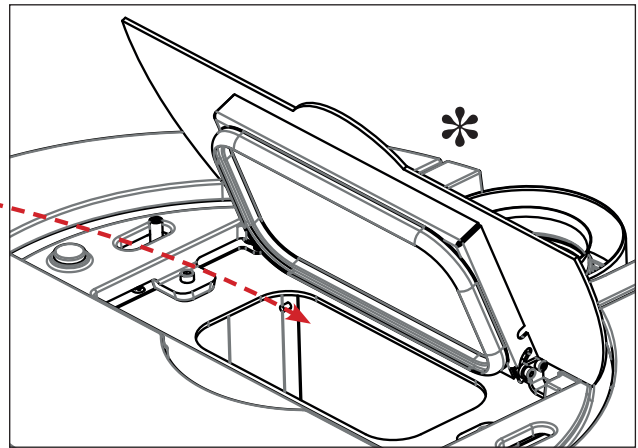

FUEL

Use Class A1 wood pellets conforming to the UNI EN ISO 17225-2 standard or similar local regulations envisaging, for example, products with the following characteristics:

- diameter 6 mm
- length 3–4 cm
- humidity <10%

For reasons relating to safety and environmental protection, DO NOT burn plastic, painted wood, coal or bark fragments in the stove.

Do not use the stove as an incinerator.



Caution
Using fuels other than those specified can damage the appliance.



When the stove is hot, DO NOT PLACE the bag of pellets on the top.
Use the glove when loading the stove while it operates and is therefore hot to the touch.
Take care not to touch the fume exhaust pipe when hot.



EXPANSION

As with all appliances, the stove heats up and cools down during its various operating stages. This implies normal expansion movements. These expansions may cause slight settling noises that cannot constitute grounds for complaints.

ODOURS

During the first ignitions, there may be a slight smell of paint, which will disappear within a short time.



The product can only be started up once the claddings have been mounted.
Connect the product to the electricity supply only after having completed its assembly and mounted the cladding. Otherwise there is a risk of having live electrical parts accessible.

OPERATION

Mode	Settable parameters
MANUAL	<ul style="list-style-type: none"> power level ventilation level (if there are two or more fans, they can be adjusted separately)*
AUTOMATIC	<ul style="list-style-type: none"> desired room temperature ventilation level *
CRONO	<ul style="list-style-type: none"> desired room temperature, selected per day of the week ventilation level*

* by lowering ventilation, the product can also automatically modulate the power to maintain maximum performance and avoid overheating. Where necessary, a safety function is provided: if for reasons of use or installation the set ventilation does not allow the necessary heat dissipation, the maximum ventilation is automatically started.

The product also has the following supplementary functions.

Function	Modes in which it can be activated	What it does
Stand-By	automatic crono	when the desired temperature is reached, the product switches off and then back on again when the temperature drops
RELAX (not provided for some types of products)	manual automatic crono	enables natural convection mode (fan off), thus reducing the power
EASY TIMER	manual automatic	can be used to programme the switching off/on after a set number of hours (maximum 12 hours)



INTERFACE

The product can be managed alternatively as follows

STANDARD

- **Bluetooth** REMOTE CONTROL: can be used for all functions, near the product
- **The Mind** APP : useful for all functions at home with direct connection or outside the home with internet connection and registration.

By purchasing the Edilkamin **optional elements**:

- **VOICE CONTROL SYSTEMS:** Alexa or Google Home



N.B. The minimum system requirements to use the The Mind Apps on mobile devices are the following:

Operating System iOS 14 or higher or Android 9.0 or higher.

On iPhone 6S, 7 and 8, the “zoom” function of the display cannot be used.

Moreover, we would like to inform you that HUAWEI devices (and associated brands, such as: HONOR), are not compatible with The Mind Apps.

This information may be subject to changes or updates: always refer to www.edilkamin.com/it/tecnologie-edilkamin.

If necessary, a few functions can also be managed from a

- **SAVE PANEL:** placed on the product

OPTIONAL ELECTRICAL CONNECTIONS

On the product (accessible by removing the coating, with the electricity off and only by qualified technicians) a dedicated low voltage terminal block can be found

-Pin 1-2 = zone 3 ambient input = probe or thermostat of the relative zone

-Pin 3-4 = zone 2 ambient input = probe or thermostat of the relative zone

-Pin 5-6 = home automation input = commercial telephone dialler or remote On-Off or Thermostat.

NOTE:

The connections must be made by qualified personnel, with the electricity disconnected.

More info for installers on the site.

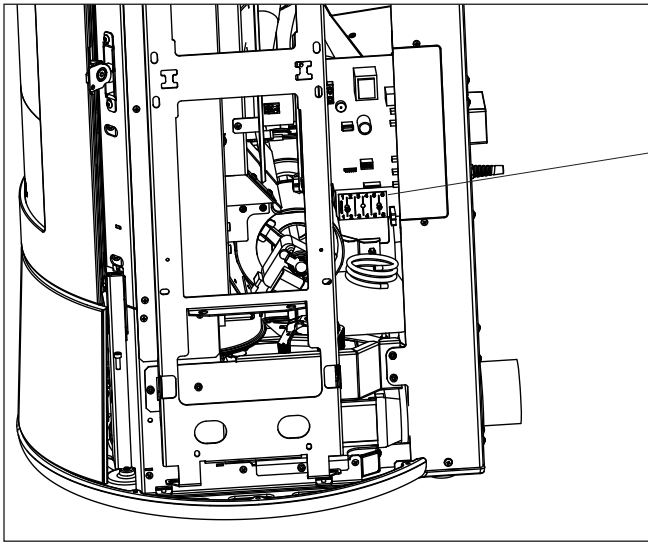

terminal block example

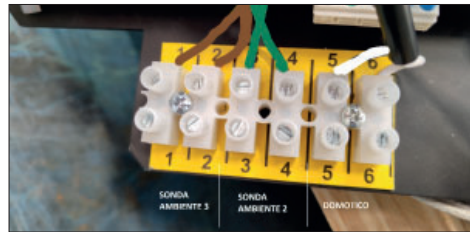

example

ENGLISH

In case of connection of probes or thermostats on the room inputs, the relevant parameters must be set in the Technical Menu of the appliance.

There are two possible modes of operation. The installer can help you choose, according to your needs:

	Thermostat on home automation contact	Thermostat in place of the ambient probe on the electronic board
ACTION	The product turns on/off without any modulation.	the product modulates, goes into stand-by and turns on/off

REMOTE CONTROL

The remote control has specific functions for three distinct figures:

- **USER** of the product (operations not protected by password)
- **INSTALLER** (operations with dedicated password because any errors can jeopardise the product's operations and SECURITY)
- **EDILKAMIN TECHNICAL ASSISTANCE CENTRE (TAC)** (operations with dedicated password because any errors can jeopardise the product's operation and SECURITY).

Characteristics:

Module for RF transmission and reception with 2.4 GHz frequency - Recommended power supply 3 x AA slimline 1.5 VDC batteries (with at least 1600 mAh capacity).



Risk of explosion if the batteries are replaced with other unsuitable batteries.

REMOTE CONTROL POWER SAVING

After 20" of non-use the backlighting decreases and after a further 10" the display switches off. If any button is pressed with the display on, the counter resets. If any button is pressed while the display is off, the display and the backlighting will switch on and the counter will reset.

This only refers to the remote control, not the product itself.

In normal use, the remote control's batteries should last a year. This duration is for illustrative purposes only. Edilkamin and the reseller will not consider claims for battery life under any circumstances.

If on the initial start-up the language was not set, the screen for setting the language will appear. Choose the language with the +/- buttons and confirm with OK.



Current room temperature

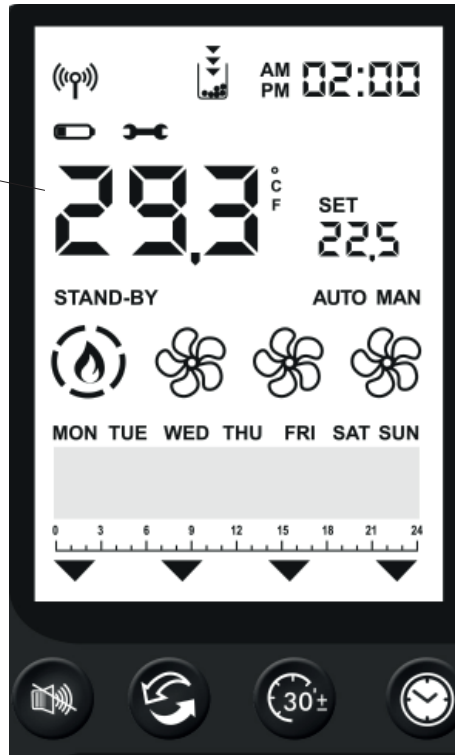

Target room temperature



Bluetooth communication present between the product and the PCB. If there is no communication, the symbol disappears.



On only if the battery is running out.



Maintenance necessary symbol.

Appears after a certain number of hours of operation. In some models the symbol may be linked to a fuse problem on the board. In any case, contact the TAC.



The relative function is active (Relax – airKare – EasyTimer – Crono).

EasyTimer and Crono cannot be activated simultaneously.



Reserve indicator. It switches on if the function is active. The arrows switch on in sequence to signal that the tank must be filled.



Presence of flame and stove power

POWER ON

POWER LEVEL 1

POWER LEVEL 2

POWER LEVEL 3

POWER LEVEL 4

POWER LEVEL 5





Visualisation of the status of the fan(s).

If the product has not heated up, no symbol will appear.

- FAN OFF: 
- SPEED 1 
- SPEED 2 
- SPEED 3 
- SPEED 4 
- SPEED 5 
- AUTOMATIC 



Indicates that the product has switched off after the target has been reached with stand-by mode active. DOES NOT indicate that the function is enabled.

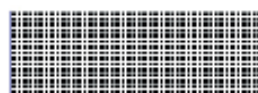

Bottom bar for "Weekly Hour Schedule" and "Messages".



Automatic or Manual mode: the product's air power depends on the room temperature or is set by the user.

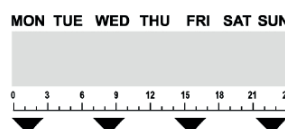

Days of the week and time bar. They only appear if the timer (Crono) has been activated.



Setting. Indicates that the remote control is in the setting mode. The settable value will appear in the bottom bar.



Digits for SET-POINTS. Setting of the various SET-POINTS: temperature, power, fan speed.

POWER ON/POWER OFF

These operations will take a few minutes, during which the flame must appear or extinguish. Simply wait without taking any action.

The ON/OFF button is used to manually start the on or off phase.

During the switch-on,

the display will show the status (CLEANING; SWITCH-ON; etc.)

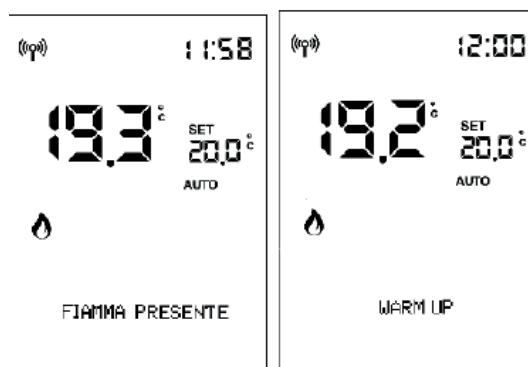
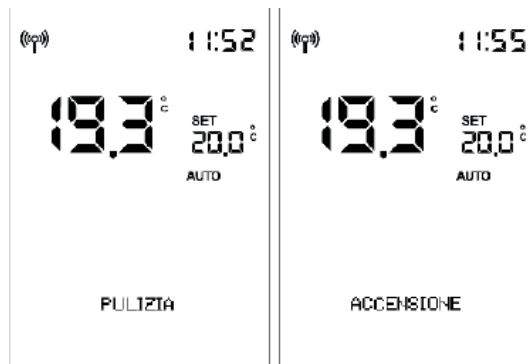

During switch-off,

the display shows the message "SHUTDOWN".



If time programming is active,

the status and programming are displayed alternately (3 seconds) on the status bar:

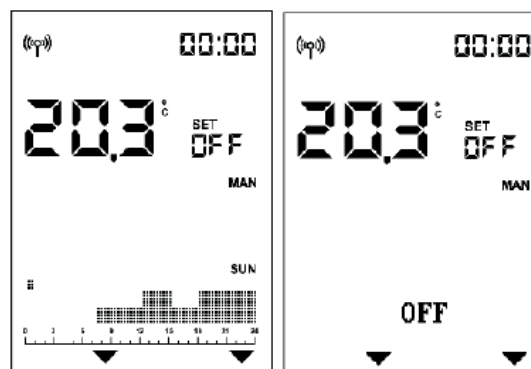

AUTOMATIC and MANUAL setting

Press the AUTO/MAN button to switch from manual to automatic mode or conversely.

AUTOMATIC

MANUAL

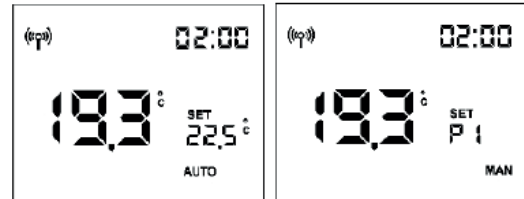

In AUTOMATIC mode:

Setting the room temperature (read by the remote control, which should be in the room where the product is installed).

Example: press a button and activate the display, then press the  button

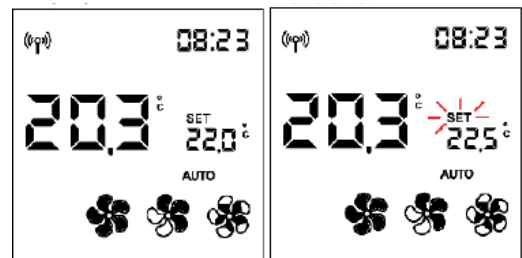

In MANUAL mode:

Setting of the power

Modify the power level (displayed by the flame symbol) using the “+” and “-” buttons.

For example: press any button and the display will activate, then press the  button

“flame” symbol

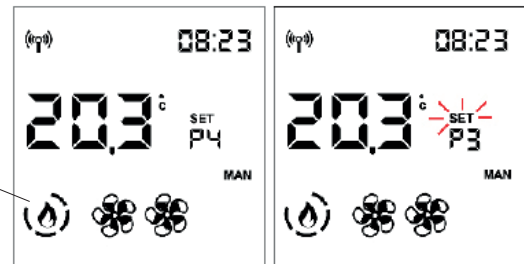



The setting can be confirmed with the  button or by waiting 5” without pressing any button. After confirming, SET will stop flashing.



NOTE:

With the timer active and the product switched off, neither the temperature nor the power can be adjusted.

- FAN ADJUSTMENT

The setting can be made with the stove turned OFF or ON.
 If the backlight is switched off, it can be activated by pressing any button.

Then by pressing the button  or  SET flashes and instead of the environment Set, the indication of the number of the fan being edited appears (F1).

The fan speed can be increased or decreased with  or  in the following sequence:

- 1 -2 - 3 - 4 - 5 - AUTO - for the front fan (1)
- OFF-1-2-3-4-5- AUTO for ducted fans (2 and 3)

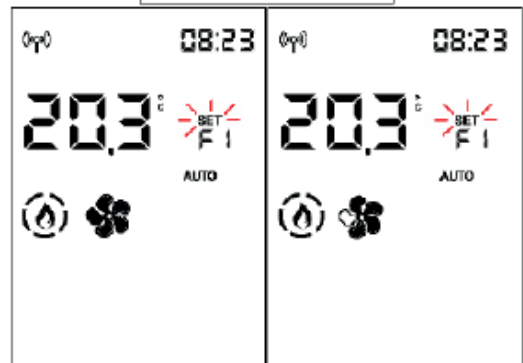
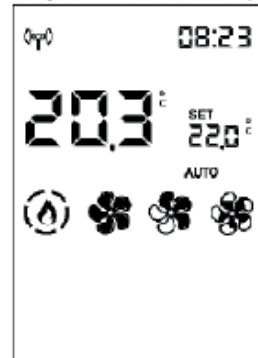

with button 

with button 

You can confirm the setting with the  button and then move to the next fan, if present (only for PLUS ducted versions), otherwise you can exit the fan setting page and "SET" will stop flashing.
 Wait 5" without pressing any button to exit the fan setting, and SET will stop flashing.

Pressing the  button to confirm will take you to the next fan (Fan 2), if present.



Pressing the  or  button modifies the fan speed.

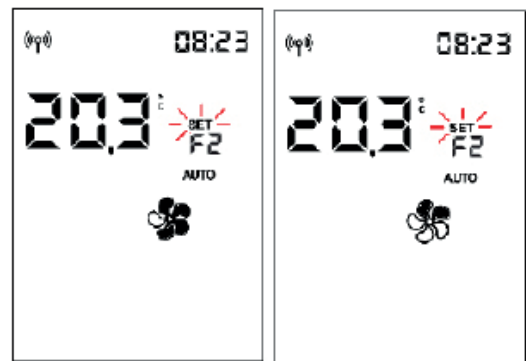

You can confirm the setting with the  button and then move to the next fan, if present, otherwise you can exit the fan setting page and "SET" will stop flashing. Alternatively, wait 5" without pressing any button to exit the fan setting, and "SET" will stop flashing, even if there are other fans.

Pressing the  button to confirm will take you to the next fan (Fan 3), if present. Waiting 5" without pressing any button takes you back to the home page with the modified SET.

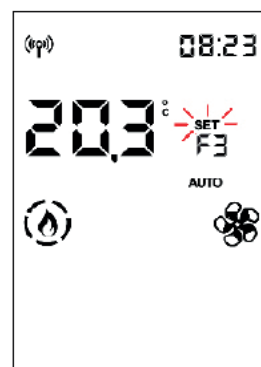

WITH OPTIONAL ROOM PROBE

DUCTED ZONES 2 AND 3 ROOM SET-POINT

The setting can only be made with ducted-air stoves. If two or more optional room probes are connected and activated, it is possible to set the relative room set-point and display the room temperature.

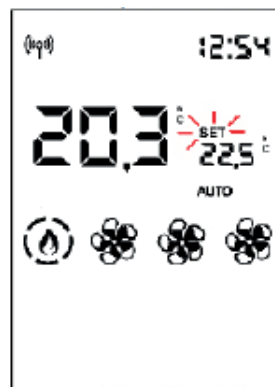

After setting the installation room temperature (or with the room power in manual mode), wait 5" without pressing any button and "SET" will flash then you will exit the settings page.

Otherwise, if you confirm with the  button, you can set the room set-point for zone 2 (if the probe is present and active) indicated on the bottom bar.



Press OK to move to the next zone (zone 3), if present, or exit.

- RELAX FUNCTION

Natural convection function (without ventilation) with automatic power limiting.

This function is available in all modes: automatic, manual and crono.

Press the  button to activate the Relax function.

Its activation on the display will be signalled by the arrow relative to the Relax button

Again by prolonged pressing of the  button, the function is disabled.

The product reduces its power output and after a few minutes switches the fan off too.

NOTE:

While the Relax function is active, it is not possible to increase the power to level P5.

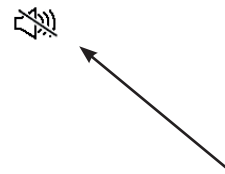
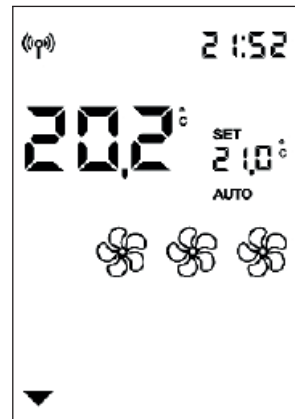

- AIRKARE FUNCTION



This function is available as a standard feature on certain models and as an optional feature on other models: check which model you have.

The function, if available, can be activated with the product either on or off, in any mode (except in alarm mode).

The airKare can be activated or deactivated by pressing the dedicated  button

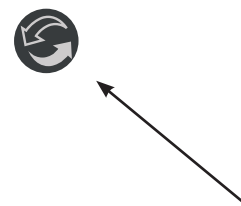
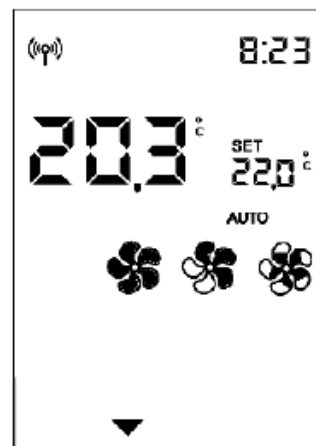

Its activation on the display will be signalled by the arrow relative to the airKare button.

- EASY TIMER FUNCTION (delayed switching off and on)

This function switches the product on/off after a set period from activation of the function.

This is convenient if you go to bed and want the product to switch on/off after a few hours (maximum 12 hours).

The Easy Timer function can be activated by pressing the dedicated button



By activating the Easy Timer function with the product on, the switch-off time can be set with ½ hour intervals.

By activating the Easy Timer function with the product off, the user sets the switch-on time.

Pressing the OK button or after 5" without pressing any button, the countdown will start with 5-minute intervals.

Example: Switch-ON in 1/2 hours' time.



The bar will continue to show the countdown which decreases until the product switches on or off.

The Easy Timer function can be deactivated by pressing the dedicated button.

The display will show an arrow above the button and the countdown.

To vary the timer before the switching on or off, it must be deactivated and then reset.

CRONO

After setting the times, temperatures or power levels in the CRONO MENU, if the product is in automatic mode, the timer will work at room temperature, otherwise at the power setting.

Pressing the  button allows for switching from Crono in Temperature and Crono to Power and vice versa.



Briefly pressing the  button activates or deactivates the timer (programmed in advance from the app or remote control).

NOTE

The timer is programmed from the MENU. The timer button is only used to activate/deactivate the function.

- MENU

It can be accessed by pressing the  button and the first Menu item will appear.

You can scroll the menu items with the  and  buttons, and enter the item with the  button

The menu items appear in the following order:

- STAND-BY**
- PELLET LOAD**
- CRONO**
- TEMP. CRONO**
- DATE-HOUR**
- LANGUAGE**

The following functions must be taken into account only following indications from the technician.

Therefore, we do not report the complete explanation in this document

- DISPLAY**
- INFO**
- SOFTWARE**
- DATA**
- ALARMS**
- PELLET FALL**
- PELLET SENSOR**
- TECHNICAL MENU**
- SET TEMPERATURE**

The set-point digits contain the progressive number of the menu item, while the status bar includes the description of the menu item in large letters.

NOTE

Depending on the version, the order of the items may vary.



We recommend, at the end of installation and commissioning, to check all the daily operations and useful documents with the technician.

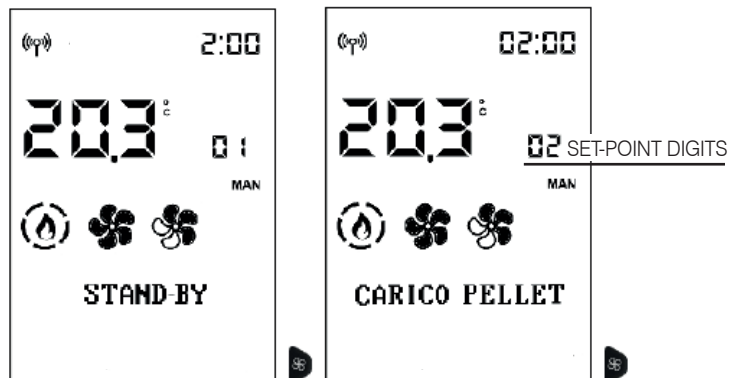



To exit the menu, press 

STAND-BY



When the Stand-by function is active, in the automatic and crono modes, the product switches off once the temperature set-point is reached and turns on again when the room temperature drops below the chosen value.

When the Stand-by function is not active, the product sets itself to minimum power when the temperature set-point is reached.

To access the function from the main menu (as indicated in the Menu section above), press the MENU button.

You can scroll the menu items with the  and  buttons, and enter the item with the  button

After entering the Stand-by function, the display will show the name of the function on the first line of the status bar and the current value on the second line (OFF if deactivated, ON if active).

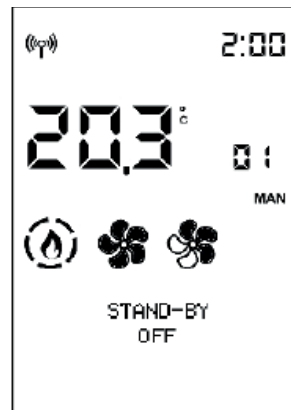

The  and  buttons can be used to modify the value from Off (function deactivated) to On (activated) and the  button can be used to confirm.

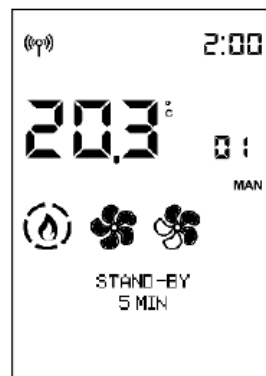

Pressing the  button with the value ON activates the function and the display will propose to choose how many minutes must pass before the device switches off in stand-by mode.

(example 5 minutes)



The  and  buttons can be used to modify the time, and the button  to confirm

Pressing the  button automatically takes you to the first level.





PELLET LOADING

Allows you to load pellets after the pellet tank has been completely emptied.

Useful for the technician during the initial start-up.





Available only in the OFF status. Any attempt to activate the function in other statuses will not be allowed.

To access the function from the main menu (as indicated in the Menu section above), press the MENU button.

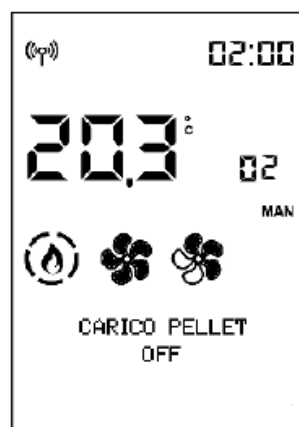
You can scroll the menu items with the  and  buttons, and enter the item with the  button

Once you have entered the **PELLET LOAD** function, the display shows the name of the function on the first line of the status bar and the current value on the second line (OFF if disabled, ON if enabled).









The  and  buttons can be used to modify the value from Off (deactivated) to On (activated) and conversely, while the  and  buttons are used to adjust it.

Pressing the  button automatically takes you to the first level.

- CRONO



To access the function from the main menu (as indicated in the Menu section above), press the MENU button.

You can scroll the menu items with the  and  buttons, and enter the item with the  button

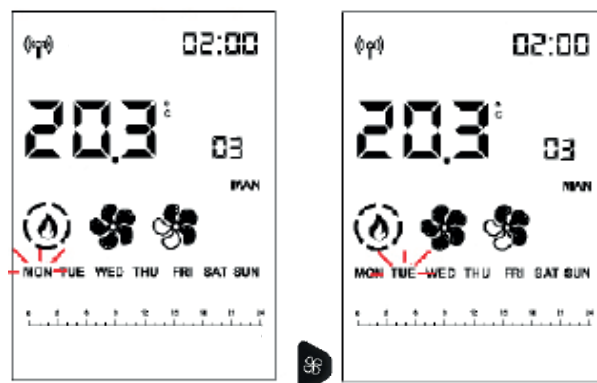

Choose the day of the week by scrolling the  and  buttons (you will simultaneously see the programme for that day) and confirm with the  button.



The cursor (rectangular) positions itself on 00:00.
The time at the top RH shows the start of the time slot



Use the  and  buttons to scroll the time with 1/2-hour steps, by moving the cursor and displaying the pre-set level.



The  and  buttons can be used to modify the temperature levels (OFF – T1 and T2) or the power levels (OFF – P1 and P5).



After reaching 23:30 you must go backwards.

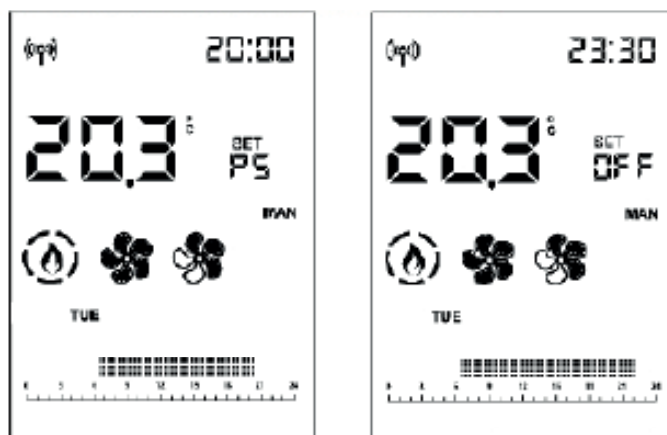

If you shift by pressing and holding the  or  buttons for more than 2", you copy the previous level onto the next level with a 1/2 h frequency per second.

The level can be copied also with backward shifts.



After setting the entire day, confirm with the  button



The copied day of the week flashes and you can shift to the next day using the  and  buttons

Confirm with the button



Briefly pressing the  button allows you to exit the programming mode, but the programme will not activate.

To activate it, you must briefly press the  button again from the main page.

NOTES



The switching on and off of the product can be forced with the timer active, by pressing the ON/OFF button for 2".

Only with the Stand-by function active will the product switch off once the set temperature has been reached.



TEMP. CRONO (T1-T2)

Temperature setting for timer T1 – T2



To access the function from the main menu (as indicated in the Menu section above), press the MENU button.

You can scroll the menu items with the  and  buttons, and enter the item with the  button

After entering the T1-T2 function, the display will show the name of the function on the first line of the status bar and the current value of T1 on the second line. T1 is the lowest temperature, T2 the highest.

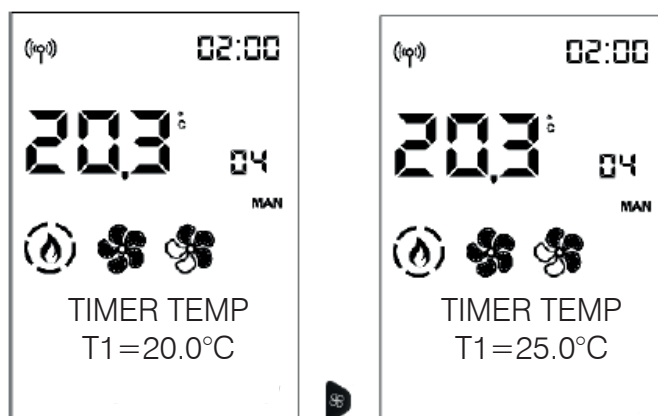
Use the  and  buttons to move to set-point T2 setting.



Modify the values with the  and  buttons and confirm with the  button

Pressing the  button automatically takes you to the first level.



DATE-HOUR

Can be used to set the current date and time.

To access the function from the main menu (as indicated in the Menu section above), press the MENU button.

You can scroll the menu items with the  and  buttons, and enter the item with the  button

After entering the Date-Time function, the display will show the name of the function on the first line of the status bar and the current value of the first setting (12/24 hours) on the second line.

You can switch from 12 to 24 hours using the  and  buttons and confirm with the  button



You reach the AUTO SUMMER TIME item (OFF if deactivated ON if activated)

You reach the WEB SYNC item (OFF if deactivated ON if activated)

At the end the item SET HOUR will appear and it will be possible to modify the hours first with buttons + and - and confirm with the  button

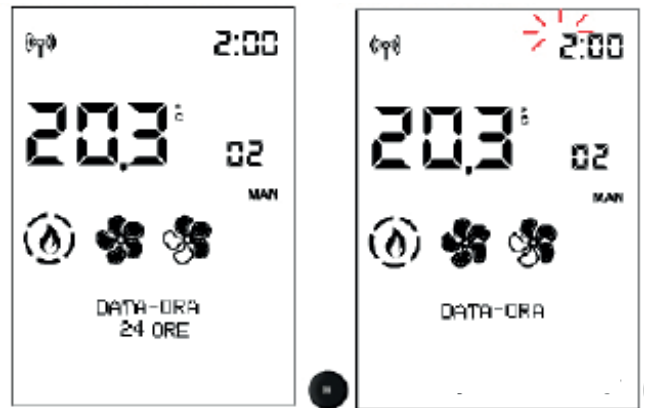
The minutes will then flash



The hours will then flash and can be modified using the  and  buttons, then confirmed with the

 button

The minutes will then flash.





If the product is connected to the cloud, the date and time can be set from the web.

If the product is connected to a smartphone, the date and time can be set using the app.

LANGUAGE

Selects the language.



To access the function from the main menu (as indicated in the Menu section above), press the MENU button.

You can scroll the menu items with the  and 

buttons, and enter the item with the  button

After entering the Language Menu item, the name of the function appears on the first line of the status bar and the current value on the second line (ENGLISH)



Modify the language using the  and  buttons then exit and confirm with the  button

Pressing the  button automatically takes you to the first level.

The following functions must be taken into account only following indications from the technician. Therefore, we do not report the complete explanation in this document.

DISPLAY

Allows you to change the brightness of the display and an acoustic signal when the keys are pressed

BRIGHTNESS ON

Indicates the backlight percentage of the display.
You can switch from one percentage to the other with buttons + and - and confirm with OK button

STBY BRIGHTNESS

Indicates the backlight percentage of the display before entering energy saving mode

TIME ON

Indicates the time the display remains illuminated

STANDBY TIME

Indicates the amount of time the display remains illuminated before entering power saving mode

BEEP



Allows to enable an acoustic signal when the buttons are pressed (OFF if deactivated ON if activated)

INFO

These readings should only be done when requested by the technician.

The technician understands the diagnostic meaning of the messages and values, and may ask you to read them to him/her if you experience problems.

To access the function from the main menu (as indicated in the Menu section above), press the MENU button.

You can scroll the menu items with the  and  buttons

Pressing the  button automatically takes you to the first level.

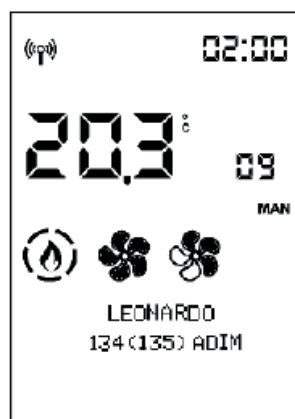
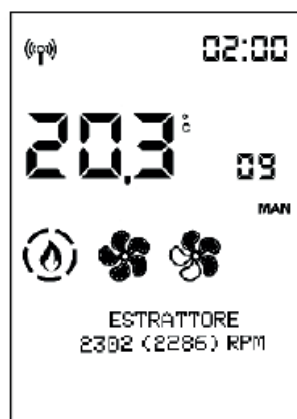
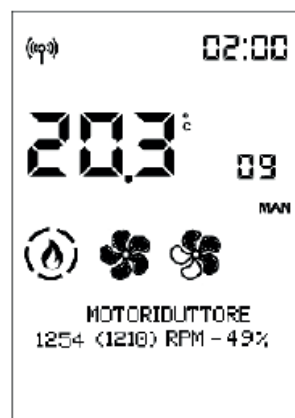
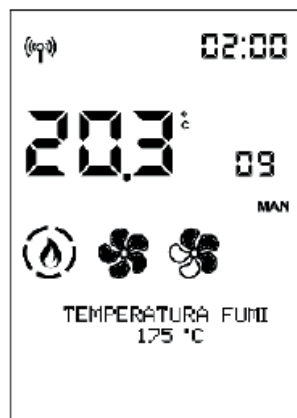

- INFO (info for INSTALLER continues)

They provide instant situation values.

Flue temperature indicates the value of the temperature read inside the product. To be read only under the guidance of the Technical Assistance Centre

Auger motor: indicates the speed set and read. Useful for understanding any anomaly in the motor that loads the pellets. To be read only under the guidance of the Technical Assistance Centre

Extractor: indicates the speed set and read. Useful for understanding any anomaly in the engine that creates depression in the combustion chamber. To be read only under the guidance of the Technical Assistance Centre

Leonardo: indicates the target value set and read. To be read only under the guidance of the Technical Assistance Centre

Fan1: indicates the output voltage. To be read only under the guidance of the Technical Assistance Centre

Ignition plug (spark plug): indicates whether the ignition component is on or off. Useful in the ignition phase to understand functionality.

Home automation contact: indicates whether ON or OFF. Useful for understanding functionality.

Radio signal: indicates the signal strength in milliwatt decibels. Admissible values from 0 to -95dB

- SOFTWARE

Indicates:



- the firmware version of the electronic board (basic board)
- the firmware version of the control panel
- the database (associated by the Technical Assistance Centres with the products)

To be read only under the guidance of the Technical Assistance Centre

DATA

Information of the product's operation log can be scrolled with the  and  buttons

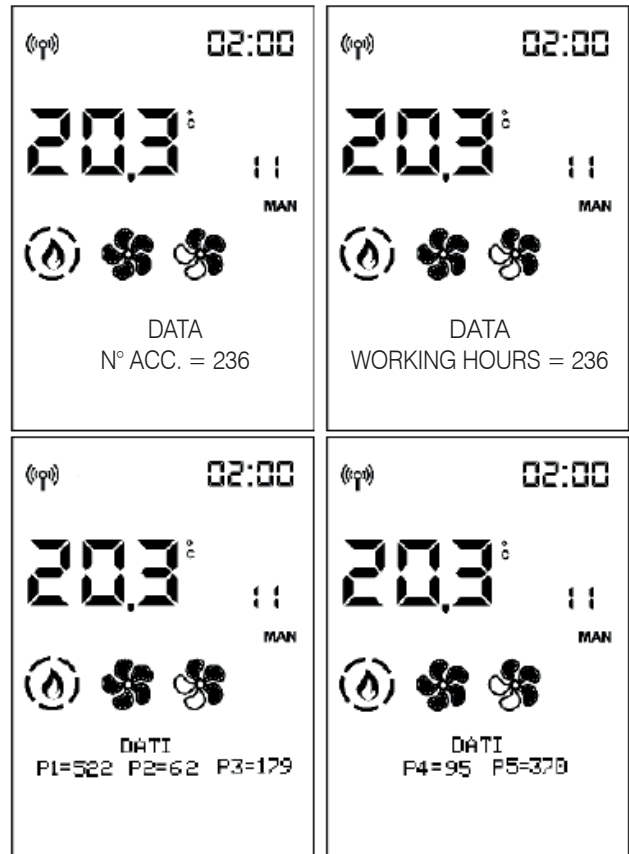

To access the function from the main menu (as indicated in the Menu section above), press the MENU button.

You can scroll the menu items with the  and  buttons, and enter the item with the  button



Pressing the  button automatically takes you to the first level.

ALARMS

Information of the product's operation log can be scrolled with the  and  buttons.

Readings to be carried out under the guidance of a technician. The meaning of the abbreviations is in the dedicated paragraph
The alarms are arranged from the most recent to the oldest.



Exit with the button 

PELLET FALL

Allows to set the auger motor in continuous cycle or in steps. To be carried out **ONLY UNDER THE GUIDE OF A TECHNICIAN**.

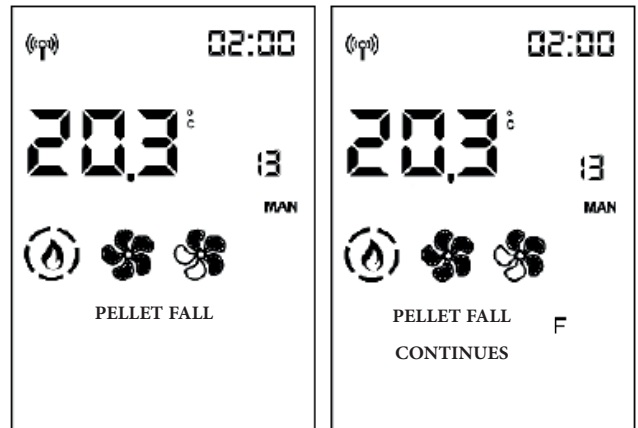

PELLET SENSOR

Allows you to set ON or OFF of the pellet level sensor.

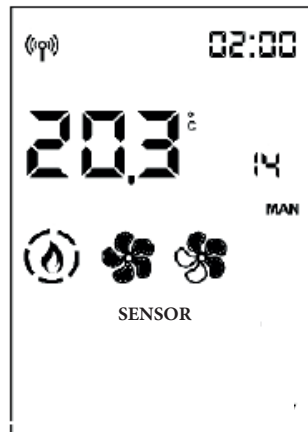

TECHNICAL MENU (for TECHNICIANS ONLY)

Accessible only by technicians with password (1111). Once the password has been entered, confirm with the  button

If you enter with the installer password (1111) you will only access the following installer parameters/settings:

- **FLAME TYPE**
- **PELLET TYPE**
- **PARAMETERS**



- FLAME TYPE (for the TECHNICIAN ONLY)

In correct installation conditions, with the Service Centre parameters appropriately adjusted, with quality pellets, the intensity of the flame is adjusted:

- STANDARD
- ECO
- PLUS

After entering the Technical Menu, the first item, "FLAME TYPE", will appear

You can enter the Flame Type setting using the  button

while the  and  buttons can be used to modify the correction value.

Pressing the  button automatically takes you to the first level.





NOTES



inappropriate changes can cause the product to seize up

Information on how to use these functions is only available to technicians in the appropriate web area.



- PELLET TYPE

You can scroll the Technical Menu items with the  and  buttons until you reach "PELLET TYPE"

Enter the Pellet Type (%) setting with button  and the value can be modified with button  and 

Use the  button to exit and return to the Technical Menu

In correct installation conditions, with the Service Centre parameters appropriately adjusted, with quality pellets, the pellet load is adjusted



MEDIUM

HIGH

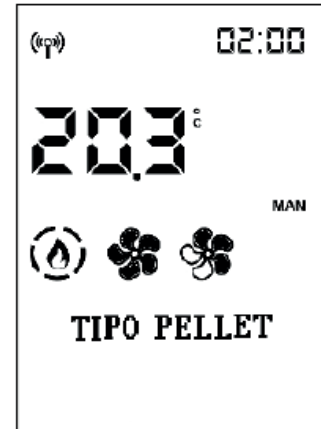
LOW





- PARAMETERS

Scroll through the items of the Technician Menu with buttons  and  up to the item "PARAMETERS".

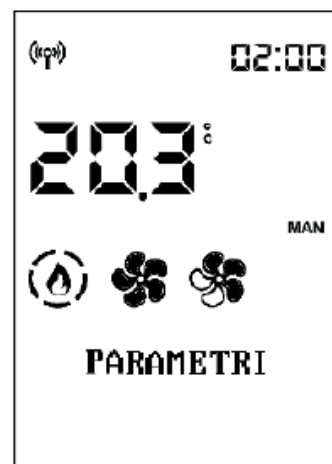
You enter the Parameters with button , the first parameter is displayed.



Scroll through the parameters with  and  and the value can be modified with buttons  and .

If you entered the Technician Menu with the Installer Password, only the Installer parameters appear, otherwise all the parameters appear.

PARAMETERS (continue PARAMETERS for INSTALLER)

SENS. PLT LEVEL: enables or disables the possibility for the end customer to view and choose the status of the pellet reserve indicator

AIRKARE FUNCTION: allows to select IF Airkare is active and on which room size (SMALL, less than 30 m³, or BIG) or not active (OFF)

AIRKARE RESET : allows to reset the working hours of airKare

DUCTING 2: allows you to activate the speed of the ducting fan at maximum (ON-OFF)

DUCTING 3 allows you to activate the speed of the ducting fan at maximum (ON-OFF)

NUMBER OF FANS: enables or disables the possibility for the end customer to operate the fan if present.

ROOM INPUT: allows to choose which item the end customer reads and adjusts on the Home display. It depends on the type of plant:

- PROBE: room probe, standard in the product
- THERMOSTAT: enables the thermostat, which can be installed in place of the room probe.

ROOM2/CYL.INPUT: defines the item to be enabled according to the connected component.

- NO INPUT: default
- PROBE
- THERMOSTAT

IN. AMB3/CYL/SE: defines the item to be enabled according to the connected component.

- NO INPUT: default
- PROBE
- THERMOSTAT

CRONO SYNCHR.: synchronises the timer

UNPAIR BLUETOOTH: enable

SET TEMPERATURE

Allows the correction of the reading of some temperature probes. To be carried out ONLY UNDER THE GUIDE OF A TECHNICIAN.

- ADJ ROOM1
- ADJ TEMPRADIO

SAVE PANEL



SAVE PANEL can temporarily make up for the absence of a remote control or smartphone, or other product management systems.

Controls the product starting from the pressing of the buttons.

When the remote control or smartphone re-establishes the communication and sends a command to the product, the remote control or smartphone will once again resume control of the product.

The display will ONLY appear if the product is controlled via the SAVE PANEL.

FUNCTIONS

To switch on the product: press the On-Off button for a few seconds.

To set the power level with the product on: press the "power" button once. Pressing it repeatedly will cause the power to increase, with the following setting appearing on the display: "P1" – "P2" – "P3" – "P4" – "P5" – "P1" – "P2" – ... The ventilation of all room fans will automatically follow the product's power level without it being possible to adjust them.

To switch off the product: press the On-Off button for a few seconds.

To unlock the product that has seized due to an alarm: press the On-Off button for a few seconds.

The table below explains in which conditions the LEDs light up:



Led 1	Presenza di tensione
OFF	Assente
ON	Presente

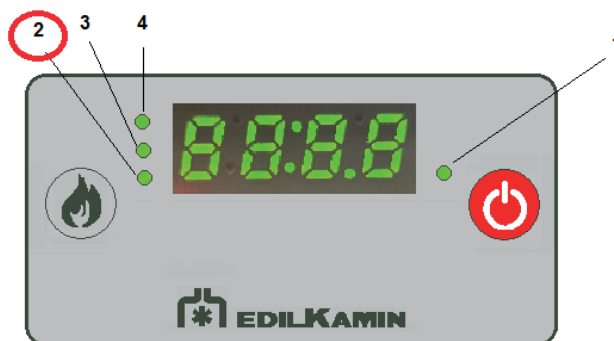

Led 2	Connessione EK Cloud
OFF	Assente
ON	Presente

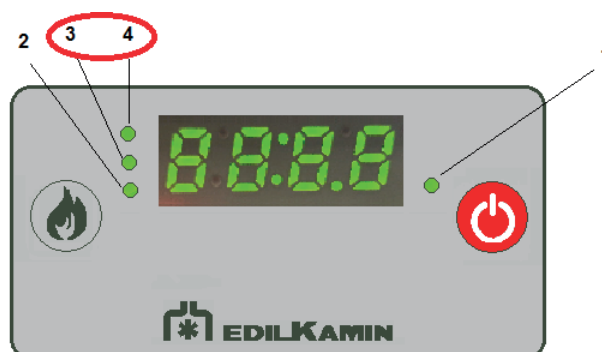

Led 4	Led 3	Connessione al router WiFi
OFF	OFF	Nessuna
ON	OFF	Scarsa
OFF	ON	Media
ON	ON	Buona

**Before doing any maintenance, disconnect the appliance from the mains.
Regular maintenance is essential to keep the appliance in good working order.
Failure to service the product properly will prevent it from working properly.
Any problems due to failure to service the stove will void the warranty.**

DAILY MAINTENANCE

These jobs should be done with the product off, cold and preferably disconnected from the mains.

A suitable vacuum cleaner is required.

The entire procedure takes just a few minutes.



Using the stove without having cleaned the burning pot can cause the gases inside the combustion chamber to ignite suddenly, resulting in detonation/breakage of the glass.

1. Open the combustion chamber door (P).
2. The burning pot (A) slips into position in its housing. Empty the ash tray (B) and the burning pot into a non-flammable container (the ashes may still contain embers and/or hot parts) or vacuum them if they are cold. Vacuum the interior of the combustion chamber, the bed, and the compartment around the burning pot into which the ash falls.
3. Scrape the burning pot with a scraper and clean out any obstructed holes.
4. If necessary, clean the glass when cold using a dedicated product (e.g. Glasskamin), which your dealer should have.

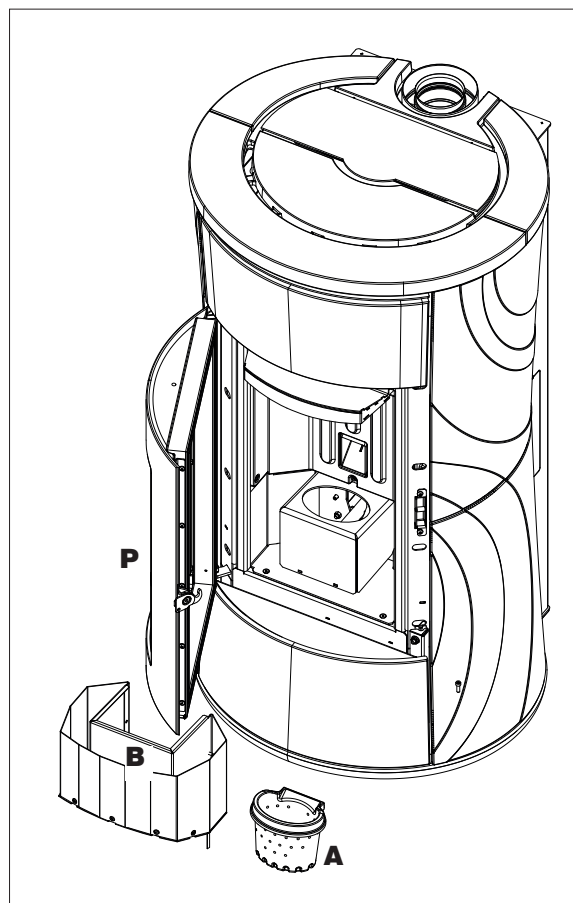
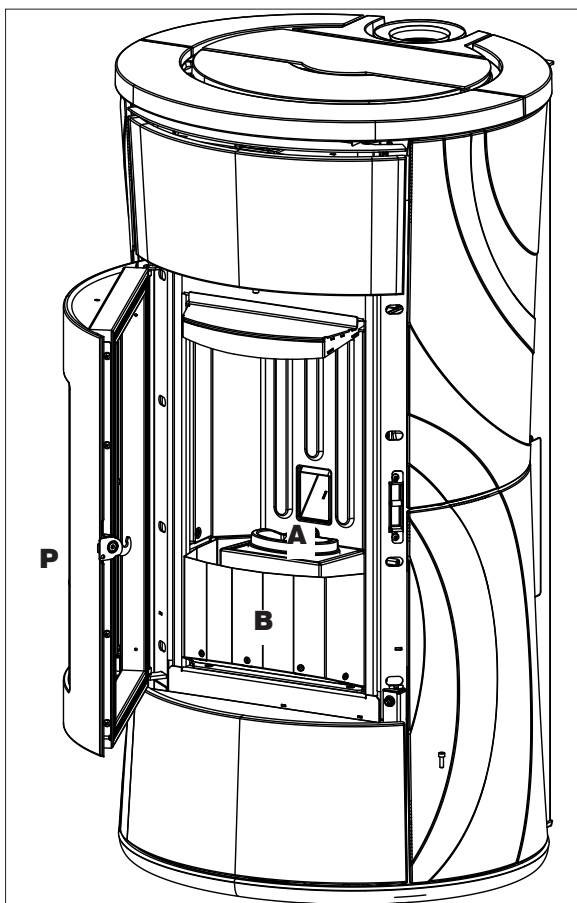

- Do not dump the cleaning residue into the pellet tank.
- Make sure that the ash tray, once re-mounted, is properly positioned in its housing, if not the glass may break by hitting it.
- Make sure that the burning pot is properly placed in its housing after maintenance operations, if not, the stove may have ignition problems.

PERIODIC MAINTENANCE (frequency depending on use to be agreed with the technician)

With the product switched off and cold, remove the deflector and vacuum the inside. Put it back with care by placing it in its housing.

The deflector is a component subject to wear. Neither Edilkamin nor the dealer shall be held liable should this component break, all the more if it breaks accidentally during handling operations.

ENGLISH

INSTALLER

72

PERIODIC MAINTENANCE (frequency depending on use to be agreed with the technician)

With the product switched off and cold, loosen the plate and clean. Make sure you put it back on correctly and close the product.

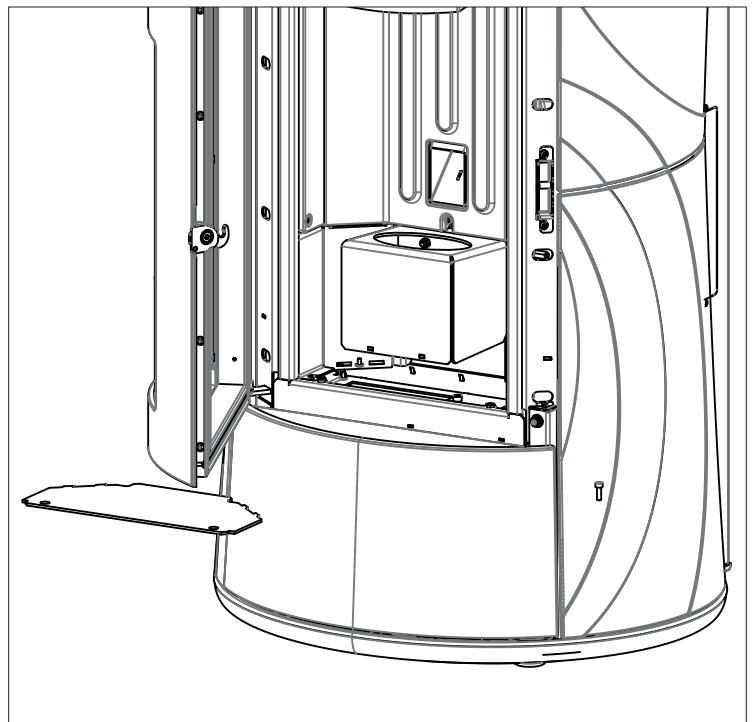

SEASONAL MAINTENANCE

(to be carried out by the technical assistance centre)

This consists of cleaning the stove inside and out. Seasonal maintenance should be performed by a qualified technician in accordance with the national and local regulations.

If the product is used intensively, it is recommended to clean the smoke duct and passage every 3 months.

You should clean the chimney system at least once a year (check local regulations for details).

If you fail to regularly clean and inspect the system, there is an increased risk of the chimney pot catching fire.

We recommend against using compressed air to clean the combustion air inlet.

REPAIRS

To be performed only by Edilkamin technical assistance centres/authorised distributors. The names of Edilkamin official authorised technical assistance centres (TAC) and distributors are available ONLY at www.edilkamin.com.

SUMMER SHUTDOWN

When the product is not used for prolonged periods, keep all its doors, hatches and covers closed. We recommend emptying out the pellet tank. Remove the batteries from the remote control. Insert dehumidifying salts in the combustion chamber. In particularly humid zones, it may be helpful to disconnect the air intake and fume coupling, and add into the combustion chamber a suitable product for absorbing moisture (e.g. bags of dehydrating salts, anti-oxidant tablets).

SPARE PARTS

- If any spare parts are required, contact your dealer or technician.
- Have any repairs carried out only by Edilkamin technical assistance centres/authorised dealers.
- The names of Edilkamin official authorised technical assistance centres (TAC) and distributors are available ONLY at www.edilkamin.com.
- Using non-original spare parts may damage the appliance and relieves Edilkamin of all liability for any resulting damages. It also invalidates the warranty on the grounds of tampering.
- Any unauthorised modifications are forbidden.

DISPOSAL

At the end of its service life, dispose of the product as required by regulations.



Seasonal maintenance should be performed by a qualified technician in accordance with the national and local regulations.



In accordance with Art. 26 of (Italian) Legislative Decree no. 49 of 14 March 2014, "Implementation of Directive 2012/19/EU on the disposal of electrical and electronic devices (WEEE)".

The crossed-out dustbin symbol displayed on equipment or its packaging indicates that the product at the end of its life must be collected separately from other waste.

At the end of its useful life, the user should therefore deliver the product to a suitable local sorted collection centre for electrical and electronic devices.

Sorted collection for recycling, treatment and environmentally compatible scrapping contributes to the prevention of negative effects on the environment and health, and promotes the re-use and recycling of the materials of which the equipment is made.

PELLET PRODUCTS

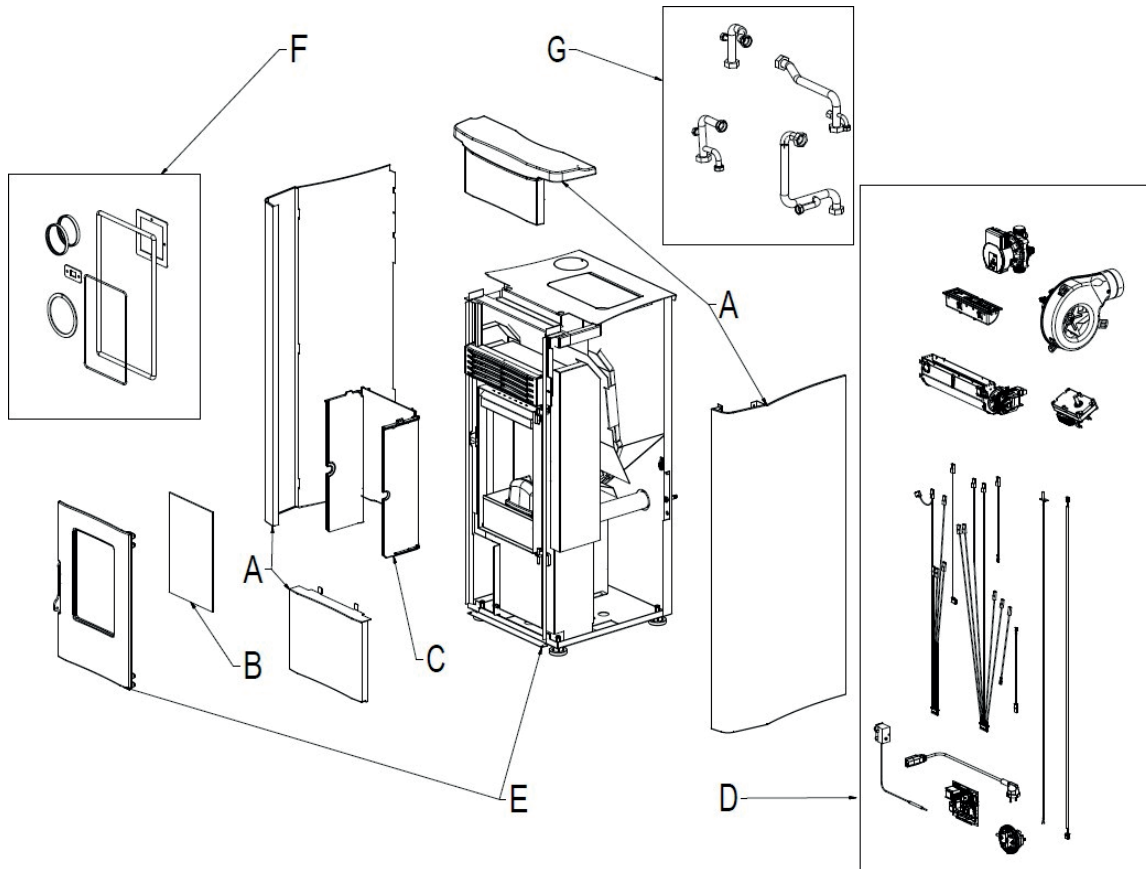

THE DRAWINGS ARE INDICATIVE

DISPOSAL OF THE COMPONENTS OF THE APPLIANCE AT THE END OF ITS SERVICE LIFE

The following table lists the components of the appliance and the indications for correct separation and disposal.

In particular, the electrical and electronic components must be separated and disposed of at the centres authorised for this activity, according to the WEEE directive 2012/19/EU.

<p>A. EXTERNAL COATING If present, dispose of separately according to its material:</p> <ul style="list-style-type: none"> - Metal - Glass - Tiles or ceramics 	<p>C. INTERNAL LINING If present, dispose of separately according to its material:</p> <ul style="list-style-type: none"> - Metal - Refractory materials
--	---

<ul style="list-style-type: none"> - Stone 	<ul style="list-style-type: none"> - Insulating panels - Vermiculite - Insulators, vermiculite and refractory materials that have come into contact with the flame or exhaust gases (dispose of in mixed waste)
<p>B. DOOR GLASS If present, dispose of separately according to its material:</p> <ul style="list-style-type: none"> - Glass ceramic (fire door): dispose of in aggregates or mixed waste - Tempered glass (oven door): dispose of in the glass 	<p>D. ELECTRICAL AND ELECTRONIC COMPONENTS Wiring, motors, fans, circulators, displays, sensors, ignition plugs, electronic boards. Dispose of separately at authorised centres, as indicated in the WEEE directive 2012/19/EU</p>
<p>E. METALLIC STRUCTURE Dispose of separately in metal</p>	<p>G. HYDRAULIC COMPONENTS Pipes, fittings, expansion tank, valves. If present, dispose of them separately according to their material:</p> <ul style="list-style-type: none"> - Copper - Brass - Steel <p>Other materials</p>
<p>F. NON-RECYCLABLE COMPONENTS E.g.: Gaskets, rubber, silicone or pitch fibre pipes. Dispose of in mixed waste</p>	

- If any problems arise, the product shuts itself off automatically.
- The display will show the reason (see below).
- Do not disconnect the power supply.
- To start the appliance again, allow the shutdown procedure to terminate and then press the ON/OFF button  on the remote control or the simplified ignition button.

- Before starting the product up again, check the reason for the shutdown and CLEAN the burning pot. The product is equipped with the necessary safety devices but, if the burning pot is not cleaned regularly as explained above, ignition may involve a slight detonation. If white smoke forms in the combustion chamber for a long time, disconnect the mains supply and wait 30 minutes before opening the door and emptying out the burning pot.

SHUTDOWN MESSAGES AND THEIR SOLUTIONS:

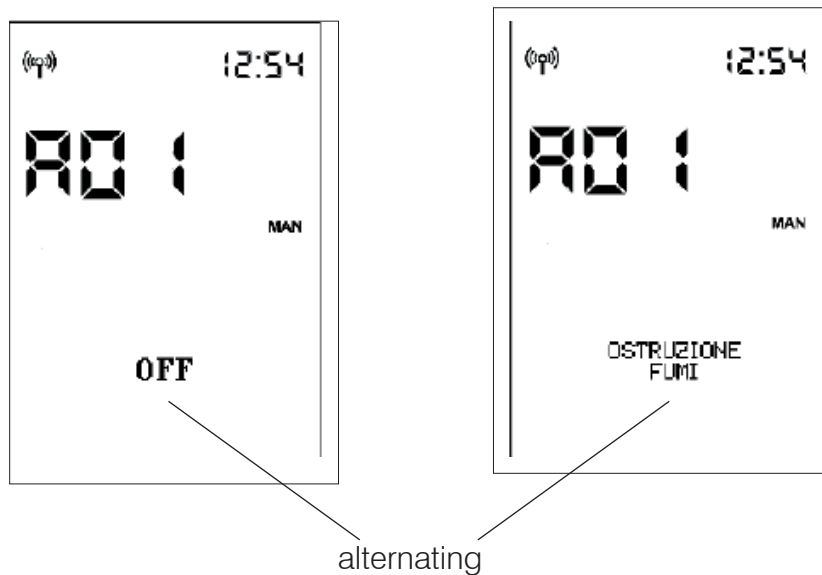

In case of an alarm, an alarm code will appear instead of the room temperature. While the product switches off, the status bar will alternately show “OFF” in large letters and the description of the alarm in small letters. If the alarm occurred with the timer active, only the timer’s activation arrow will remain displayed, while the day’s time schedule will disappear. Once the switch-off sequence terminates, only the alarm description will remain.

MESSAGE	PROBLEM	SOLUTION
A01	displays when the combustion air intake is below the set level.	<ul style="list-style-type: none"> • Check that the combustion chamber door is closed • Check the regular maintenance of the product • Check that smoke discharge and combustion air ducts are clean.
A02	displays when the circuit board is not detecting the correct speed of the fumes fan.	<ul style="list-style-type: none"> • Contact the technician
A03	displays when the thermocouple detects a fume temperature lower than the set value and interprets this as the absence of flame.	<ul style="list-style-type: none"> • Check that there are pellets in the tank • Contact the technician
A04	displays if ignition does not occur successfully in the set time.	<p>There are two possibilities: NO flame:</p> <ul style="list-style-type: none"> • Check that the burning pot is seated properly and clean • Check that there are pellets in the tank and burning pot • Try switching it on with a solid ecological igniter (contact the technician beforehand and follow the instructions of the igniter supplier very carefully). <p>The operation must be regarded purely as a trial under the technician's guidance.</p>
A05	Shutdown due to air flow rate sensor breakage.	<ul style="list-style-type: none"> • Contact the technician
A06	Intervenes when the circuit board detects that the fume temperature reading thermocouple is broken or disconnected.	<ul style="list-style-type: none"> • Contact the technician
A07	Shutdown due to exceeding of the maximum smoke temperature.	<ul style="list-style-type: none"> • Check the type of pellet (contact the technician if in doubt) • contact the technician
A08	Shutdown due to excessive overheating of the product.	<ul style="list-style-type: none"> • see A07
A09	Shutdown due to gearmotor failure.	<ul style="list-style-type: none"> • Contact the technician
A10	Switching OFF due to circuit board overheating.	<ul style="list-style-type: none"> • Contact the technician
A11	Switching OFF due to the intervention of the safety pressure switch.	<ul style="list-style-type: none"> • Ensure the product and flue are clean • Contact the technician

MESSAGE	PROBLEM	SOLUTION
A12	Room temperature probe failure. The product is operating in manual mode.	<ul style="list-style-type: none"> Contact the technician
A14	Ducting room temperature probe (if present) fault. The product is operating in manual mode.	<ul style="list-style-type: none"> Contact the technician
A20	Gearmotor fault switch-off.	<ul style="list-style-type: none"> Contact the technician

**EXPANSION**

As with all appliances, the stove heats up and cools down during its various operating stages. This implies normal expansion movements. These expansions may cause slight settling noises that cannot constitute grounds for complaints.

ODOURS

During the first ignitions, there may be a slight smell of paint, which will disappear in a short time.

MESSAGES WHICH DO NOT SHUT THE STOVE DOWN, BUT ARE SIMPLY WARNINGS

LOW REMOTE CONTROL BATTERY LEVEL:

The battery symbol displays on the remote control display if the battery is low.

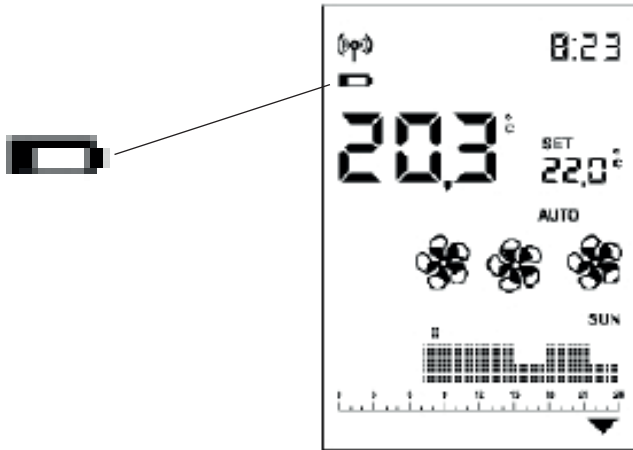

MAINTENANCE:

A spanner symbol will appear on the display after 2,000 hours of operation. The product is working, but it must be serviced by an authorised Edilkamin technician.

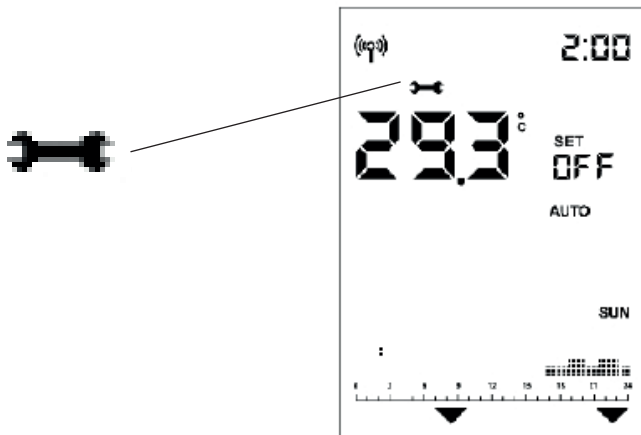

LACK OF COMMUNICATION:

In case of a prolonged lack of communication between the product and the remote control, the Bluetooth transmission icon ((P)) will disappear as well as the icons transmitted by the circuit board to the remote control. Only the room temperature and the time will remain visible.



The Wi-Fi transmission icon  will only appear if there is a connection between the circuit board and the Wi-Fi router.

PELLET RESERVE INDICATOR:

The function is only available if the pellet level sensor is installed and has been activated.

When the level sensor intervenes, the circuit board emits a single "beep" (in any switch-on or work status) and the moving reserve symbol will appear on the display.

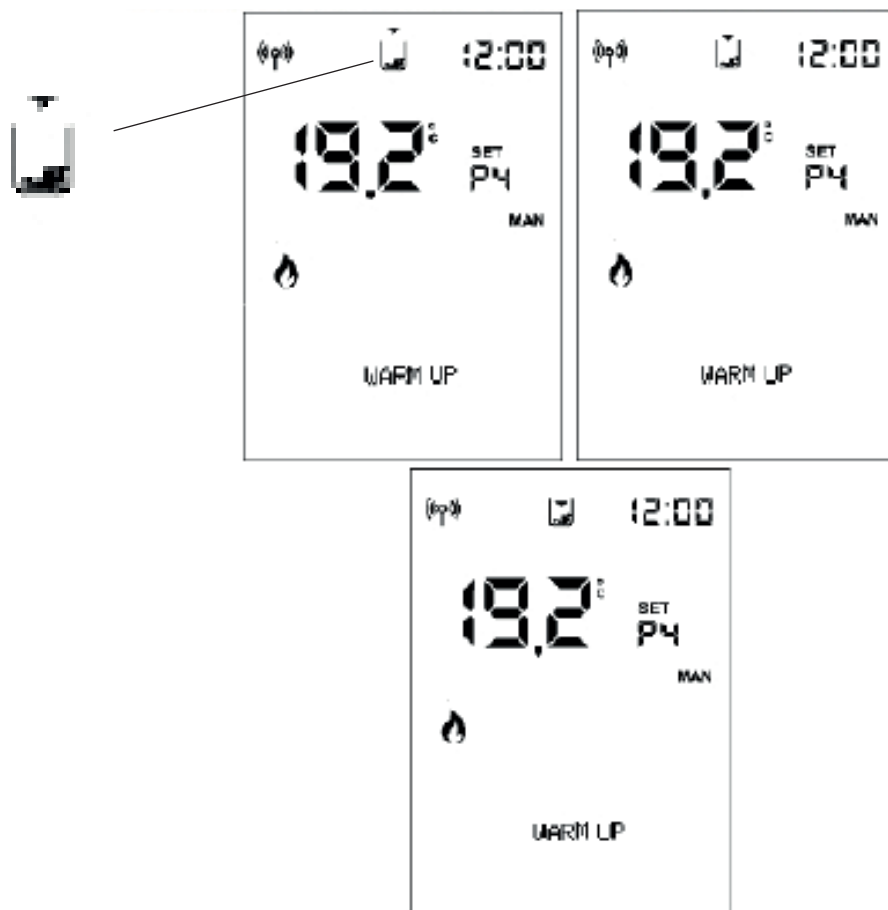

The arrows will light up in sequence to signal the need for pellet loading.



The ignition frequency is roughly 0.5 seconds.

After an interval of roughly 20/30 minutes, which varies depending on the model, the product switches off due to shortage of pellets.

If the user refills the product before the start of the switch-off procedure, the symbol disappears and the stove resumes its normal operation.

If the user fails to refill the product before the start of the switch-off procedure, the product switches off and the tank symbol remains steady lit with the 3 arrows on until the next refilling operation.

When the reserve symbol appears, the product cannot be restarted.

After reloading the pellets, the stove must be restarted manually.

If the pellets are reloaded and there is an ignition request coming from the timer, the product will restart.

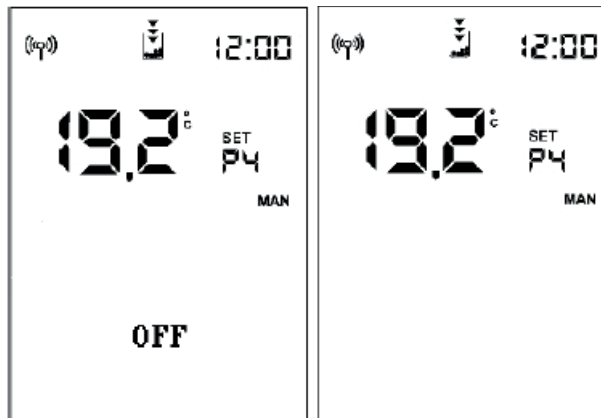

If the sensor intervenes:

- with the product OFF or in Initial Cleaning mode (following manual emptying of the tank), the final symbol will immediately appear and the stove cannot be switched on;
- during the ignition phase, the ignition sequence will be completed even if it lasts more than the 20/30 minutes of residual autonomy.

If the pellets are not reloaded, the stove will then switch off.

During a switch-off following a **BLACKOUT**, the display will alternately show the words “Black-Out” and “OFF”. Once the switch-off has been completed, the product will remain off and “Black-Out” will appear.

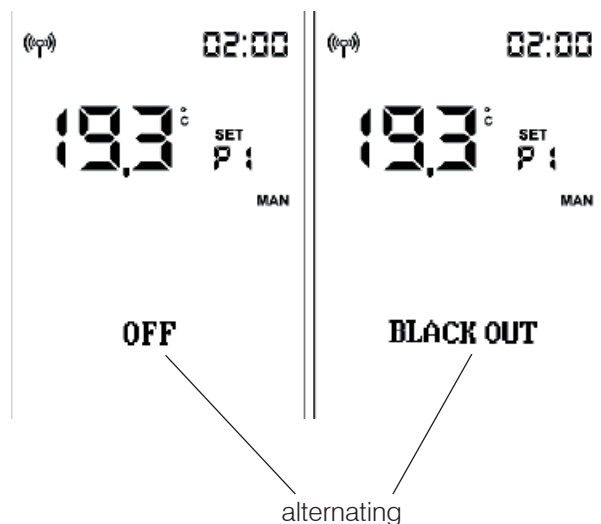

The names of Edilkamin official, authorised technical assistance centres (TAC)
and distributors are available ONLY a
www.edilkamin.com



EDILKAMIN
TECNOLOGIA DEL FUOCO

www.edilkamin.com

code 942535-GB 01.23/B